

Fasteners

Contents

Introduction513
 Screws, bolts, locking lever of screw type.....514

Washers515
 Nuts, locking lever of nut type.....515

Introduction

Slot nuts

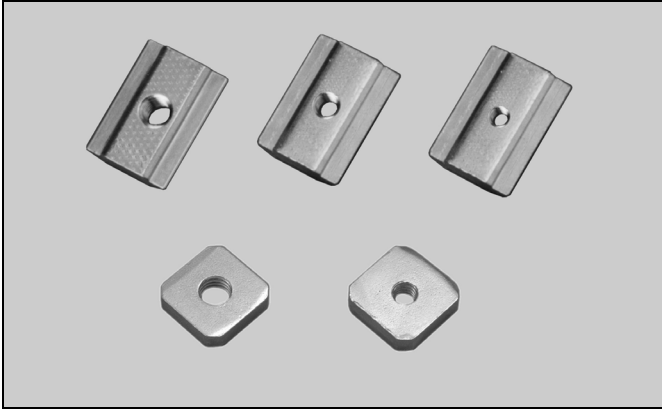

Slot nuts are used for connections to the structural system T-slots. The nuts exist in XC and XF versions.

Screws, nuts and washers



This catalogue lists a number of standard screws, nuts and washers which are needed frequently when building structural system applications.

Locking levers are recommended replacements for screws or nuts when frequent readjustment of a screw/nut connection are needed.

P0
 CC
 X45
 XS
 X65
 X65P
 X85
 X85P
 XH
 XK
 XKP
 X180
 X300
 GR
 CS
 XT
 HU
 WL
 WK
 XC
 XF
 XD
 ELV
 SC
FST
 TR
 APX
 IDX

Hex head bolt – ISO 4014/4017

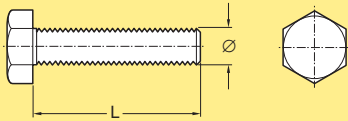

Hex head screw – ISO 4014/4017

M8, L=14 mm, Ø8 mm	M6S 8×14
M8, L=16 mm, Ø8 mm	M6S 8×16
M8, L=18 mm, Ø8 mm	M6S 8×18
M8, L=30 mm, Ø8 mm	M6S 8×30

Note. Contains 50 pcs.

Hex socket head cap screw, ISO 4762

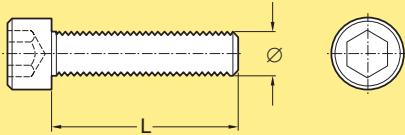

Hex socket head screws, standard
– DIN 912, ISO 4762

M5, L=12 mm, Ø5 mm	MC6S 5×12
M5, L=20 mm, Ø5 mm	MC6S 5×20
M5, L=35 mm, Ø5 mm	MC6S 5×35
M6, L=10 mm, Ø6 mm	5044478
M6, L=14 mm, Ø6 mm	MC6S 6×14
M6, L=16 mm, Ø6 mm	MC6S 6×16
M6, L=30 mm, Ø6 mm	MC6S 6×30
M6, L=50 mm, Ø6 mm	MC6S 6×50
M8, L=14 mm, Ø8 mm	MC6S 8×14
M8, L=30 mm, Ø8 mm	MC6S 8×30

Note. Contains 50 pcs.

Hex head cap screw, low head DIN 7984

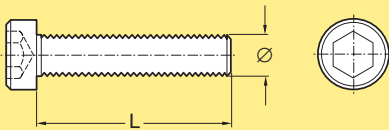

Hex socket head screw, low profile
– DIN 7984

M5, L= 8 mm, Ø5 mm	MLC6S 5×8
M5, L=10 mm, Ø 5 mm	MLC6S 5×10
M5, L=20 mm, Ø 5 mm	MLC6S 5×20
M6, L=12 mm, Ø 6 mm	MLC6S 6×12
M8, L=14 mm, Ø 8 mm	MLC6S 8×14
M8, L=30 mm, Ø 8 mm	MLC6S 8×30
M8, L=35 mm, Ø 8 mm	MLC6S 8×35

Note. Contains 50 pcs.

Hexagon socket countersunk head screw ISO 10642

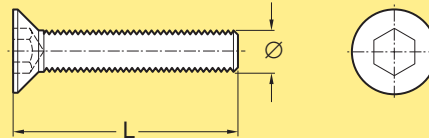

Hex socket head screw, countersunk
– DIN EN ISO 10642

M6, L=12 mm, Ø6 mm	MF6S 6×12
M6, L=14 mm, Ø6 mm	MF6S 6×14
M6, L=16 mm, Ø6 mm	MF6S 6×16
M6, L=30 mm, Ø6 mm	MF6S 6×30
M8, L=18 mm, Ø8 mm	MF6S 8×18
M8, L=30 mm, Ø8 mm	MF6S 8×30
M8, L=40 mm, Ø8 mm	MF6S 8×40

Note. Contains 50 pcs.

Selftapping screw, countersunk DIN 7500- ME

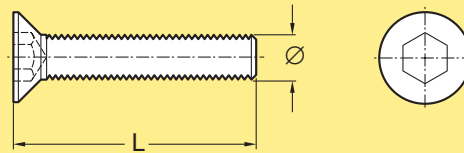

Selftapping screw
M8, L=30 mm, Ø8 mm
Countersunk

MF6S-TT 8×30

Note. Contains 50 pcs.

Selftapping screw, hex socket head DIN 7500- EE

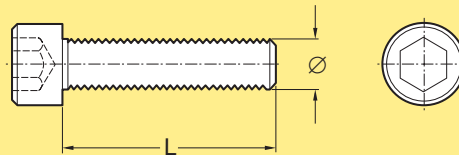

Selftapping screw
M6, L=30 mm, Ø6 mm
Hex socket head

MC6S-TT 6×30

Note. Contains 50 pcs.

T-bolt for conveyor beam

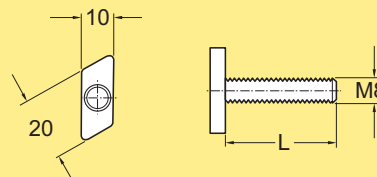

T-bolt M8

L= 17,8 mm	XLAT 17
L= 24 mm	XLAT 24
L= 35 mm	XLAT 35
L= 53 mm	XLAT 53
L= 71 mm	XLAT 71

Note. Contains 50 pcs.

Locking lever, screw type

Locking lever with M8 screw
Thread length 10 mm

XLAL 8x10

Washers

Washers

Flat washer

For M5, d=5,3 mm, D=10 mm	BRB 5.3x10
For M6, d=6,4 mm, D=12 mm	BRB 6.4x12
For M8, d=8,4 mm, D=16 mm	BRB 8.4x16

Note. Contains 50 pcs.

Nuts, locking lever of nut type

Nut for T-bolt DIN 985:1987 Class 8

Locking nut M8 for T-bolt

XLAN 8

Note. Contains 50 pcs.

Square nut for System XC T-slot

Square nut for XC
M8 thread
M6 thread

XLAQ 8
XLAQ 6

Note. Contains 50 pcs.

Nut – ISO 4032

M6 nut

M6M M6

Note. Contains 50 pcs.

T-slot nut for System XF T-slot

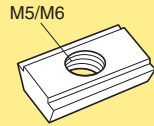
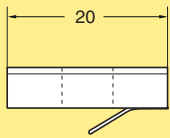

T-slot nut for XF

Steel, zinc-chromated

M5, multipack (10 pcs)
multipack (100 pcs)
multipack (250 pcs)

M6, multipack (10 pcs)
multipack (100 pcs)
multipack (250 pcs)

XFAN 5 Q10
XFAN 5 Q100
XFAN 5 Q250
XFAN 6 Q10
XFAN 6 Q100
XFAN 6 Q250

T-slot nut for System XC T-slot

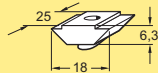
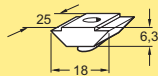
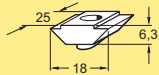

T-slot nut for XC

Steel, zinc-chromated

M5, multipack (10 pcs)
multipack (100 pcs)
multipack (250 pcs)

M6, multipack (10 pcs)
multipack (100 pcs)
multipack (250 pcs)

M8, multipack (10 pcs)
multipack (100 pcs)
multipack (250 pcs)

XCAN 5 Q10
XCAN 5 Q100
XCAN 5 Q250
XCAN 6 Q10
XCAN 6 Q100
XCAN 6 Q250
XCAN 8 Q10
XCAN 8 Q100
XCAN 8 Q250

Locking lever, nut type

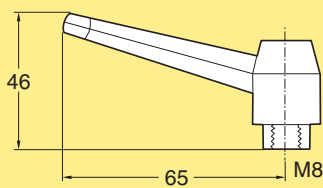

Locking lever with M8 thread

XLAL 8