

# Structural system XD

## Contents

System information.....	497	Adjustable feet.....	499	
Beams XD .....	498	Enclosure profiles.....	499	X45
Support beams.....	498	Enclosure strips .....	500	XS
Cover strip.....	498	Multiblock .....	500	X65
Angle brackets.....	498	Door accessories.....	500	X65P
Connecting strips .....	498	Components for XD doors in XD frames .....	500	X85
T-slot nut.....	499	Components for XD doors in XC frames .....	500	X85P

## System information

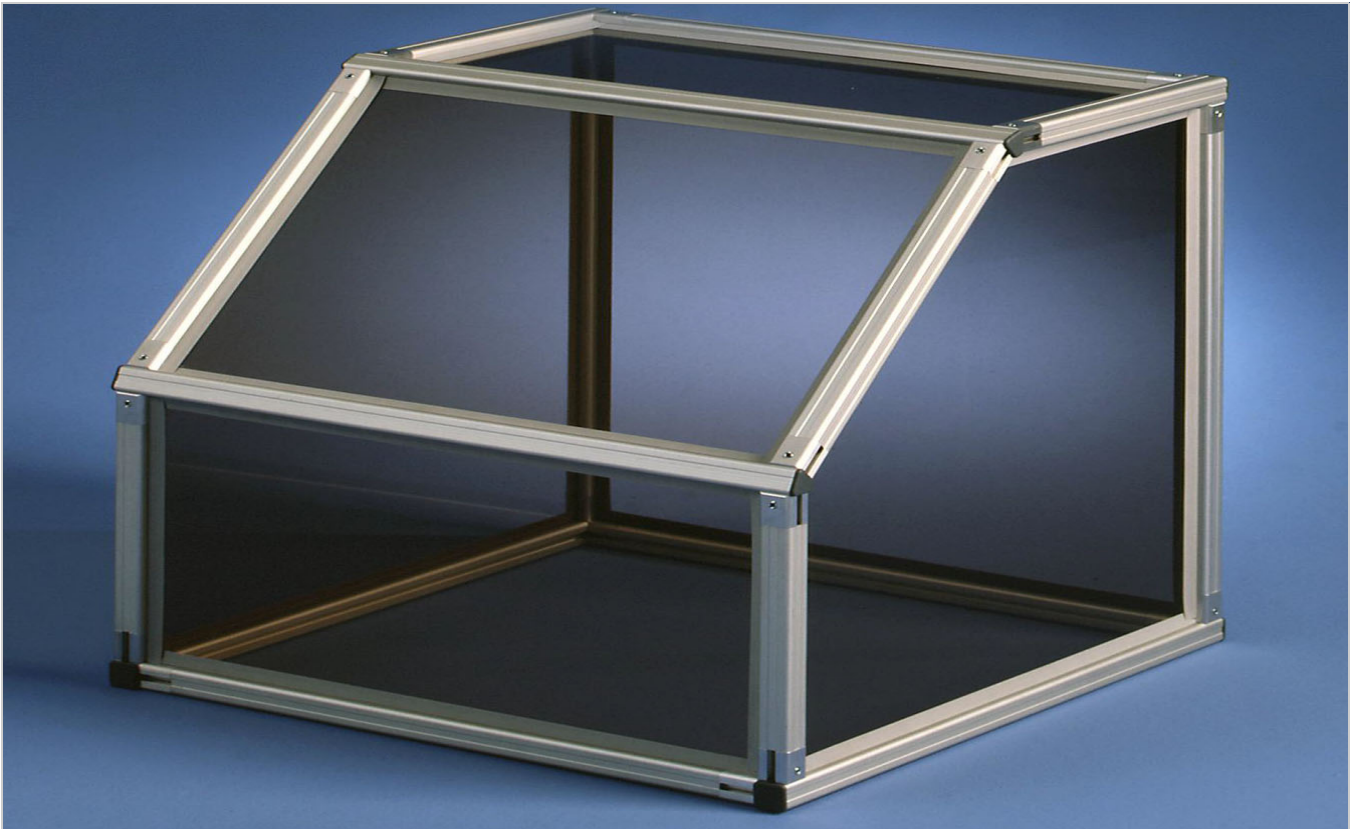

## Features

Structural system XD is based on the module 22 mm (XC: 44 mm, XF: 30 mm). Attractive styling and re-usability makes XD equally suitable for prototypes and production quantities.

Designing and building a XD structure is simple and straightforward, and the resulting design retains the flexibility typical of all products from FlexLink Systems.

- P0
- CC
- X45
- XS
- X65
- X65P
- X85
- X85P
- XH
- XK
- XKP
- X180
- X300
- GR
- CS
- XT
- HU
- WL
- WK
- XC
- XF
- XD**
- ELV
- SC
- FST
- TR
- APX
- IDX

## Beams XD

### Lengths and tolerance aluminium beams

#### "3 m" aluminium beams

If no other tolerance is stated in the catalogue all "3 m" aluminium beams will be delivered with a length of 3030 ±5 mm

The extra length compensates for cut losses on local site.

#### "L-cut" aluminium beams

If no other range is mentioned in the catalogue L-cut aluminium beams can be ordered in the range of 30-3000 mm.

Length tolerances:

Cut length L (mm)	Length tolerance (mm)
30-1000	±0,3
1001-2000	±0,5
2001-3000	±0,8

## Support beams

### Support beam 22×22

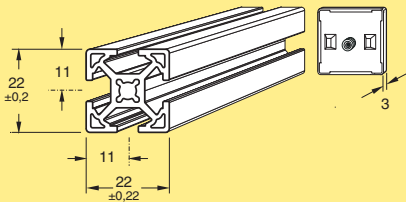

Beam 22 mm × 22 mm  
Aluminium, anodized  
Length 3 m (3030 ±5 mm) **XDBM 3x22**  
Length to order (30- 3000 mm) **XDBM Lx22**  
End cap, polyamide **XDBE 22 L**

## Cover strip

### Cover strip, PVC

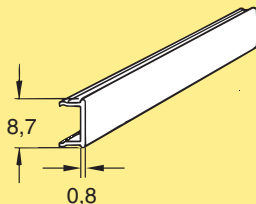

Cover strip  
Length 3 m  
Polyvinyl chloride **XDAC 3 P**

## Angle brackets

### Angle bracket, die-cast, 20×20×20

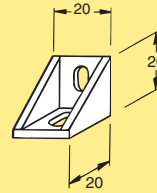

Angle bracket  
Aluminium, die-cast **XDFA 22 A**  
Mounting: MLC6S 5×8, BRB 5.3×10, XDAN 5 A

## Connecting strips

### Connecting strip

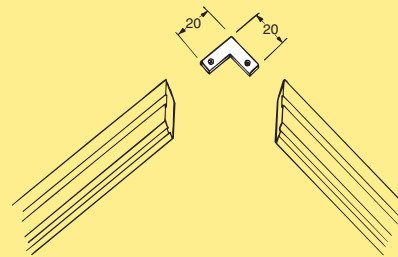

Angular connecting strip 90°  
Including set screws  
Steel, electro-zinc-plated **XDFW 9**

### Connecting strip

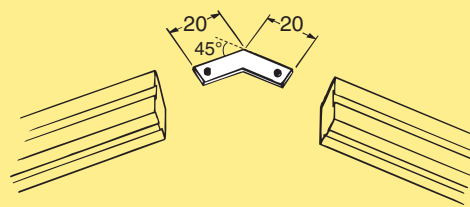

Angular connecting strip 45°  
Including set screws  
Steel, electro-zinc-plated **XDFW 9x45**

### Connecting strip

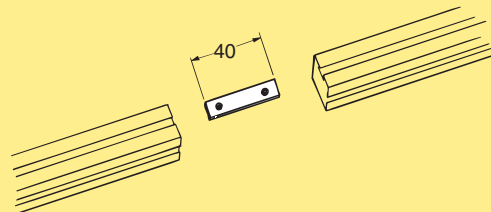

Connecting strip, straight  
Including set screws  
Steel, electro-zinc-plated **XDFC 9x40**

## T-slot nut

### T-slot nut for System XD T-slot

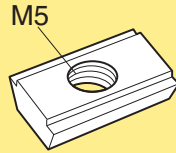
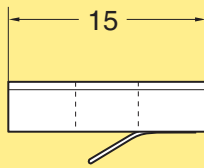

T-slot nut for XD  
Steel, zinc-chromated  
M5

**XDAN 5 A**

## Adjustable feet

### Adjustable foot

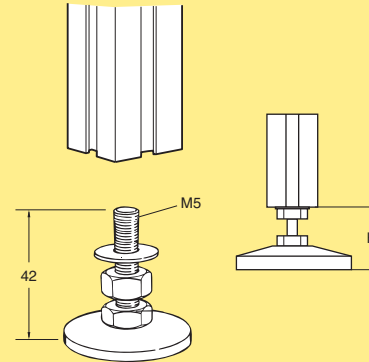

Adjustable foot (M5 screw)  
H=21-30 mm  
Steel, electro-zinc-plated  
M5 thread

**XDFS 5x30**

Including nut. Maximum vertical load 250 N

## Enclosure profiles

### Enclosure beam 22x22, four T-slots

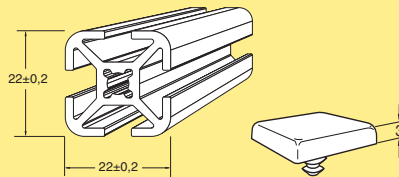

Enclosure profile, square section  
22 mm x 22 mm, four T-slots  
Aluminium, anodized  
Length 3 m (3030 ±5 mm)  
Length to order (30- 3000 mm)

**XDEB 3x22**  
**XDEB Lx22**

End cap, polyamide, grey

**XDEE 22\***

With standard XD T-slots and hole for M5  
\*Note. Contains 10 pcs.

### Enclosure beam 22x22, two T-slots

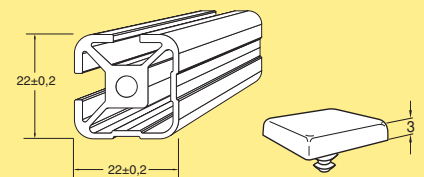

Enclosure profile, square section  
22 mm x 22 mm, two T-slots  
Aluminium, anodized  
Length 3 m (3030 ±5 mm)  
Length to order (30- 3000 mm)

**XDEB 3x22 T2**  
**XDEB Lx22 T2**

End cap, polyamide, grey

**XDEE 22\***

With standard XD T-slots and hole for M5  
\*Note. Contains 10 pcs.

### Enclosure beam 22x22, three T-slots

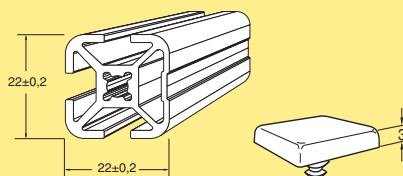

Enclosure profile, square section  
22 mm x 22 mm, three T-slots  
Aluminium, anodized  
Length 3 m (3030 ±5 mm)  
Length to order (30- 3000 mm)

**XDEB 3x22 T3**  
**XDEB Lx22 T3**

End cap, polyamide, grey

**XDEE 22\***

With standard XD T-slots and hole for M5  
\*Note. Contains 10 pcs.

### Enclosure connector kit

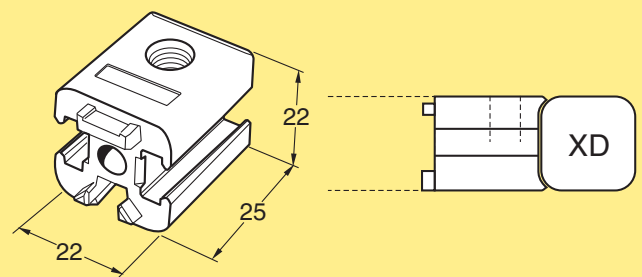

Enclosure connector kit  
Aluminium, die-cast

**XDEF 22**

Including the necessary mounting hardware

## Enclosure strips

### Rim strip

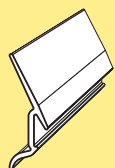

Rim strip  
Length 3 m  
Polyvinyl chloride, grey

**XDET 3 A**

### Net strip

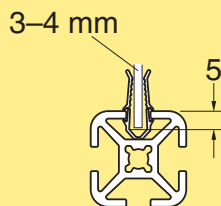
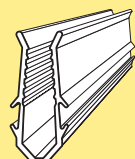

Net strip  
Length 3 m  
Polyvinyl chloride, grey

**XDET 3 C**

## Multiblock

### Multiblock

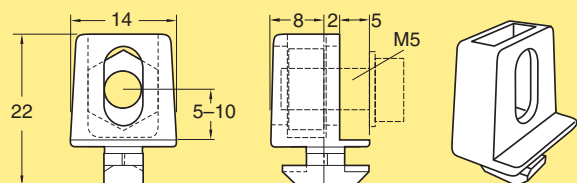

Multiblock  
Polyamide  
Including M5 square nut

**XDAM 2**

## Door accessories

### Handle assembly XC/XD/XF, polyamide

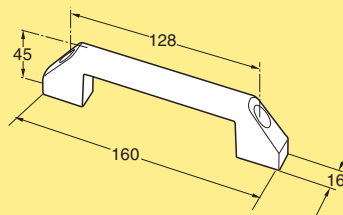

Handle assembly  
Polyamide

**XDEH 160**

Including adapter plate for XC  
Mounting XD: MC6S 5x12 (2), XDAN 5 A(2)

## Components for XD doors in XD frames

### Hinge kit XD-XD

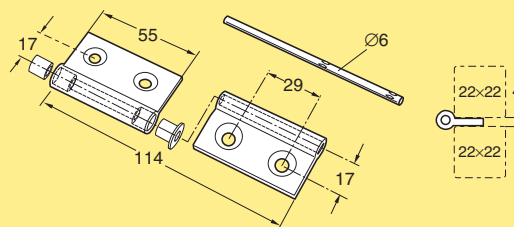

Hinge kit XD-XD  
Aluminium

**XDAH 110 B**

Including the necessary mounting hardware