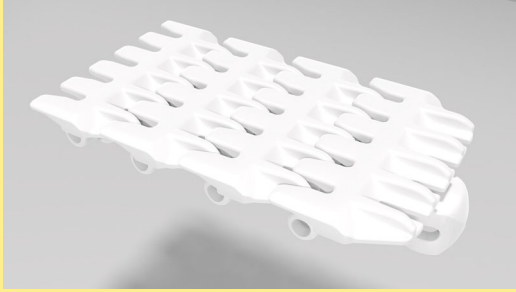
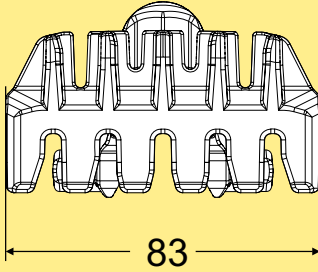
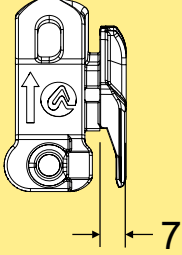

Conveyor system X85 – links and chains

Each link kit contains 10 links, 10 plastic pivots, and 10 stainless steel pins, unless otherwise specified. Material abbreviations: See page III.

Plain chain, small gap

					
Chain	Link kit(s)	Dimensions	Link weight	Material, link	Material, pivot
XBTP 5A85 K	FLX1003436			POM F	See page III
XBTPX 5A85 K	FLX1003437			POM A	See page III

Plain chain

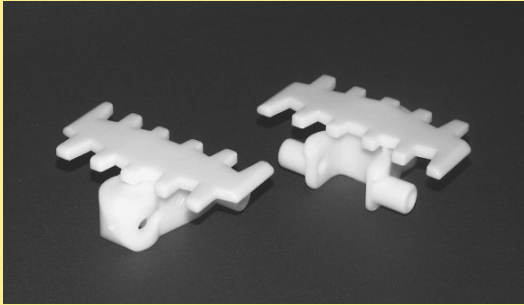
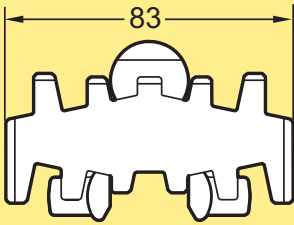
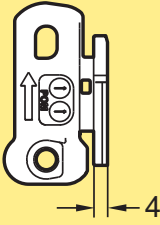
						
Chain	Link(s)	Link kit(s)	Dimensions	Link weight	Material, link	Material, pivot
XBTP 5A85	5110431	5110529		27 g	POM B	See page III
XBTP 5A85 B	5110832	n.a.		27 g	POM A GY	See page III
XBTPX 5A85	5059652	5110512		27 g	POM A	See page III
5122746	5122456	n.a.		27 g	POM A Blue	See page III
5110456	5110455	5110530		27 g	POM B polished	See page III
5110430	5110429	5110532		27 g	POM B ISD NAT	See page III
XBTP 5A85 E	5110427	5110527		27 g	POM A COND	PA66 ISD
XBTP 5A85 C	5110484	5110533		27 g	POM D	See page III
5115679	5115678	FLX1001234		27 g	POM B BK	See page III
5116324	5123282	5110837		27 g	POM B GY	See page III

Plain chain

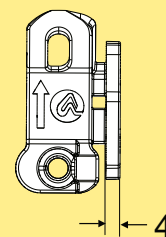
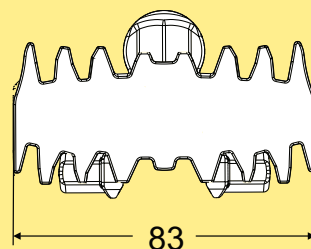
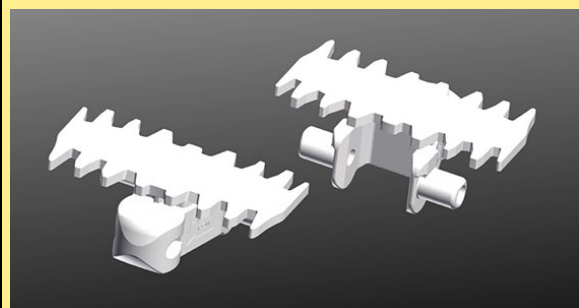

For light goods: blister packs, small boxes, etc. Max 6 mm gap between links. Minimum horizontal bend radius: 250 mm. Recommended to use with guide wheel 5055635. For flat top friction chain see XBTP 5A85 SG FA.

Chain	Link(s)	Link kit(s)	Dimensions	Link weight	Material, link	Material, pivot
XBTP 5A85 SG	FLX1006620	FLX1006630		29g	POM B	See page III

Closed top chain

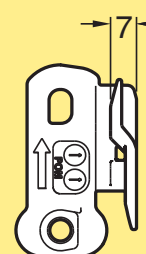
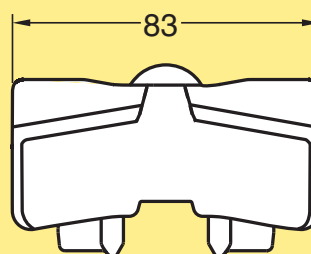
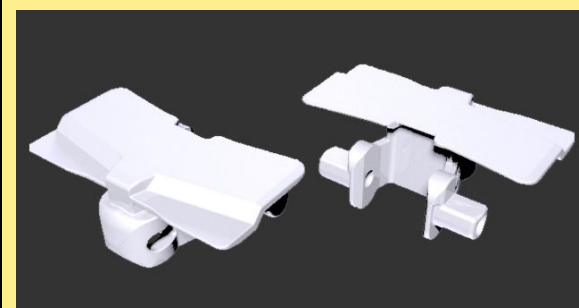

Chain	Link(s)	Link kit(s)	Dimensions	Link weight	Material, link	Material, pivot
XBTP 5A85 A	5059685	5110513			POM B	See page III

Plain chain

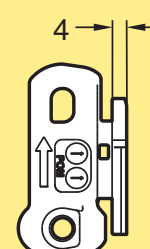
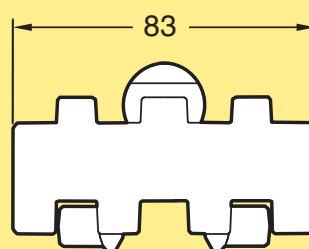
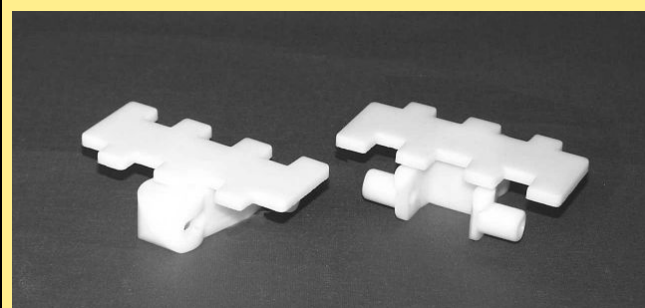

Minimum horizontal bend radius: 500 mm. Minimized gap between links.

Chain	Link(s)	Link kit(s)	Dimensions	Link weight	Material, link	Material, pivot
5110434	5110433	5110578		30 g	POM B	See page III

Plain chain

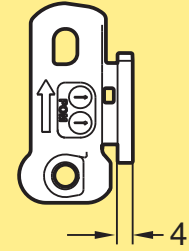
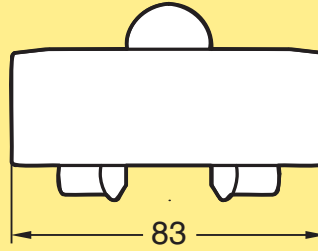
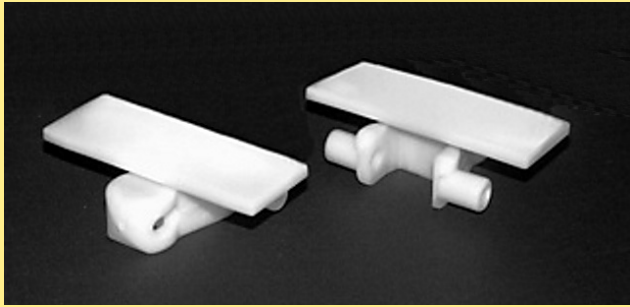

Minimum horizontal bend radius 700 mm.

Chain	Link(s)	Link kit(s)	Dimensions	Link weight	Material, link	Material, pivot
5110388	5110387	5110576		30 g	POM B	See page III

Flocked chain

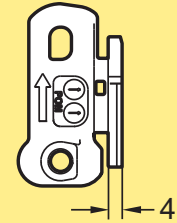
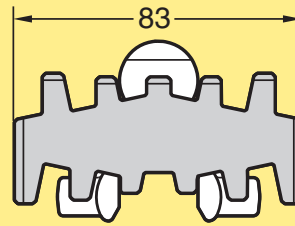

For lightweight products with scratch sensitive surfaces. Perfume boxes, cosmetic packages, CD's, video cassettes, cigarette packages. Fibre material is PA66, glued to the link using epoxy glue.

Chain	Link(s)	Link kit(s)	Dimensions	Link weight	Material, link	Material, pivot
5110492	n.a.	n.a.			POM B	See page III

Universal chain

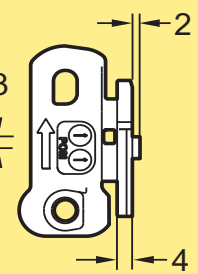
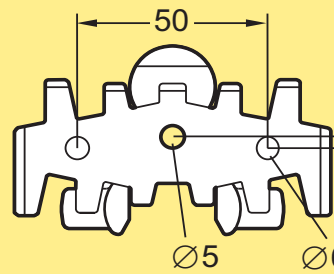
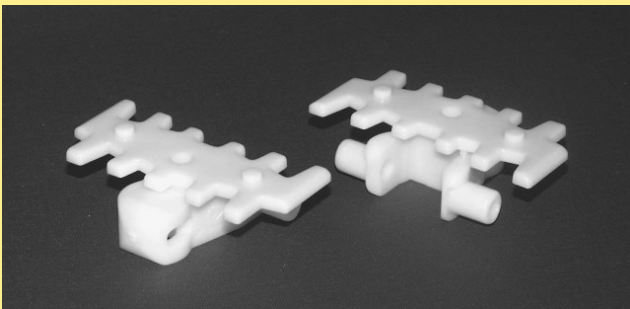

To attach customer specific cleat or fixture. The link has a hole for an M5 screw. An M5 nut will fit inside the link.

Chain	Config.	Link(s)	Link kit(s)	Dimensions	Link weight	Material, link	Material, pivot
XBTF 5A85 U PAR 1-20		5110375	5110526		27 g	POM B	See page III
		5110431*					

*Link type between main cleat links.

Friction top chain

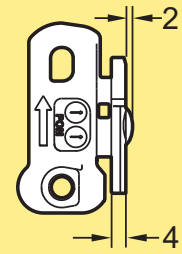
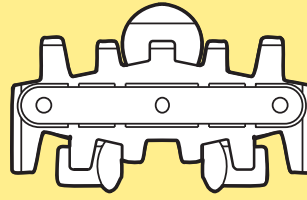
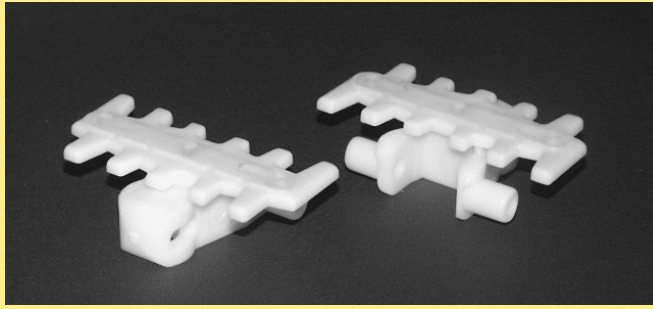

Friction insert is polyether-polyamide. Slope <math><30^\circ</math>. Paper bags, cardboard boxes.

Chain	Config.	Link(s)	Link kit(s)	Dimensions	Link weight	Material, link	Material, pivot
XBTP 5A85 F	n.a.	5110459	5110518		29 g	POM B	See page III
XBTP 5A85 FP	PAR 2-20	5110459 5110431*	5110518		29 g	POM B	See page III

*Link type between main cleat links.

Flat top friction chain

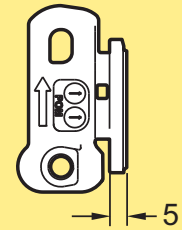
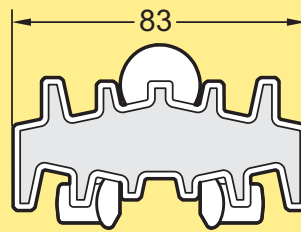
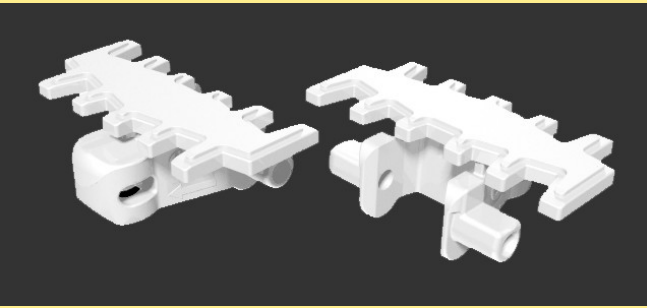

Friction insert is polyether-polyamide. Slope <math><30^\circ</math>. Light goods: blister packs, small boxes, etc.

Chain	Link(s)	Link kit(s)	Dimensions	Link weight	Material, link	Material, pivot
XBTP 5A85 FA	5110378	5110528			POM B	See page III

Flat top friction chain

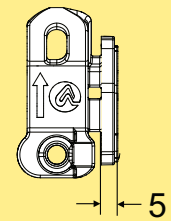
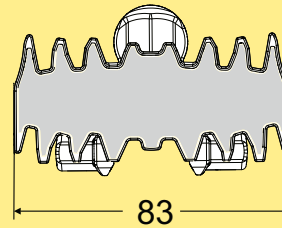
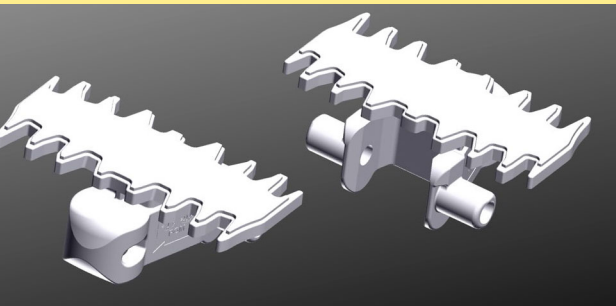

For light goods: blister packs, small boxes, etc. Max 6 mm gap between links. Friction insert is polyether-polyamide. Slope <math><30^\circ</math>. Recommended to use with guide wheel 5055635. Minimum horizontal bend radius: 250 mm. No direct food contact allowed. For plain chain see XBTP 5A85 SG

Chain	Link(s)	Link kit(s)	Dimensions	Link weight	Material, link	Material, pivot
XBTP 5A85 SG FA	FLX1006624	FLX1006631		31	POM B	See page III

Steel top chain

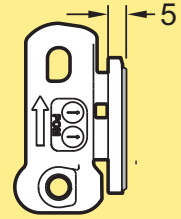
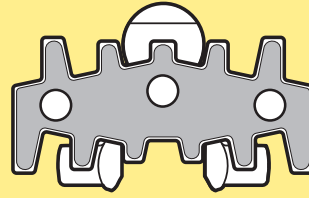
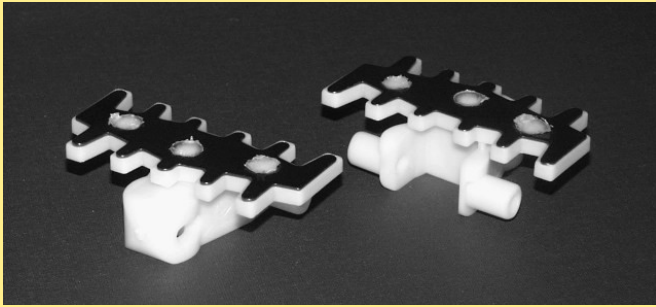

Top surface is stainless steel. Cylindrical rollers. Cast-metal products. Accumulation.

Chain	Link(s)	Link kit(s)	Dimensions	Link weight	Material, link	Material, pivot
XBTP 5A85 TF	5110436	5110519		46 g	POM B + SS	See page III

Steel chain

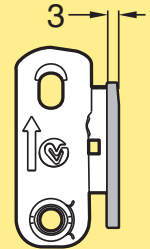
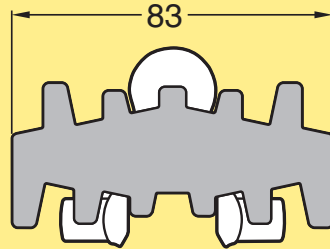
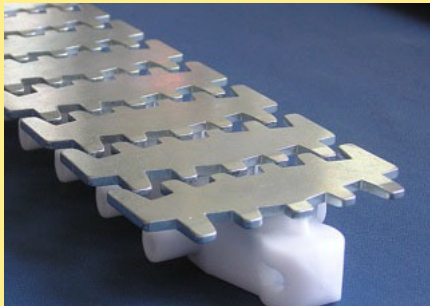

Electro-zincplated hardened steel (700HV1) throughout top part. Modification kits are required for end drive units. See instruction leaflet 6622461, and the FlexLink catalogue.

Chain	Link(s)	Link kit(s)	Dimensions	Link weight	Material, link	Material, pivot
5056849	5056847	5058301			POM A + Steel	See page III

Cleated chain

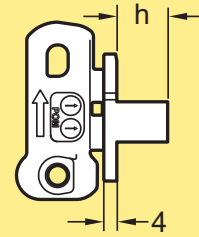
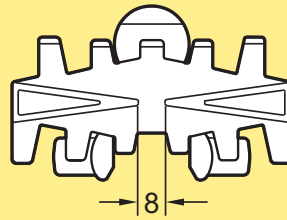
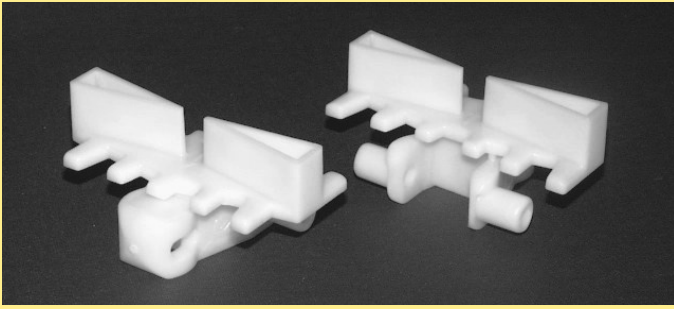

Chain	Config.	Link(s)	Link kit(s)	Dimensions	Link weight	Material, link	Material, pivot
XBTF 5A85X7 A	PAR 1-20	FLX1001032 5110431*	FLX1001076	h=7 mm	35 g	POM B	See page III
XBTF 5A85X10 A	PAR 1-20	FLX1001795 5110431*	FLX1001804	h=10 mm	35 g	POM B	See page III
XBTF 5A85X15 A	PAR 1-20	5110372 5110431*	5110516	h=15 mm	35 g	POM B	See page III
XBTF 5A85X30 A	PAR 1-20	5110374 5110431*	5110517	h=30 mm	43 g	POM B	See page III

*Link type between main cleat links.

Cleated chain

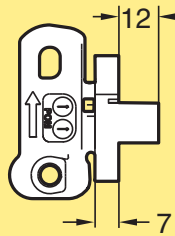
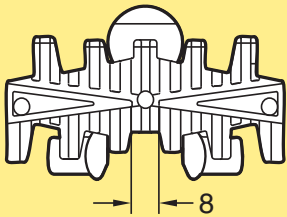
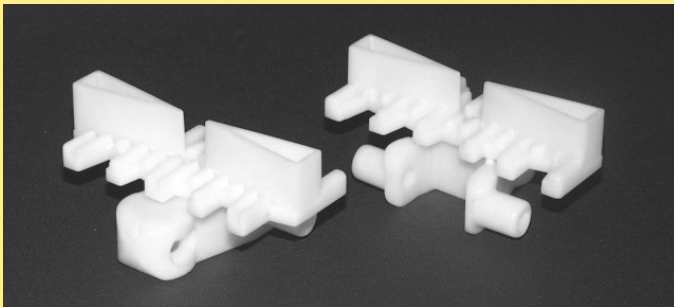

Chain	Config.	Link(s)	Link kit(s)	Dimensions	Link weight	Material, link	Material, pivot
5995237	PAR 1-20	5110393 5110394*	5110536 5110561		38 g	POM A	PVDF

*Link type between main cleat links.

Plain chain with elevated surface

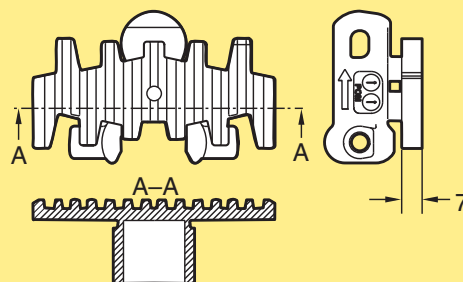
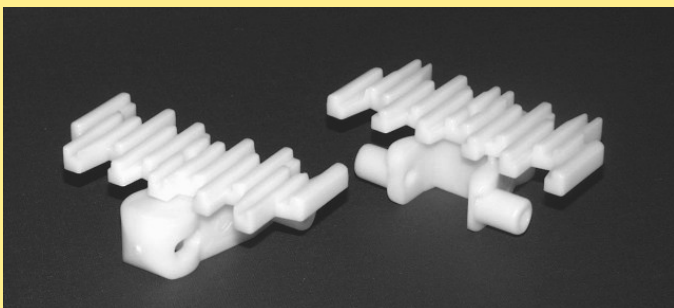

Wet applications.

Chain	Link(s)	Link kit(s)	Dimensions	Link weight	Material, link	Material, pivot
5110395	5110394	5110561		32 g	POM A	PVDF

Cleated chain

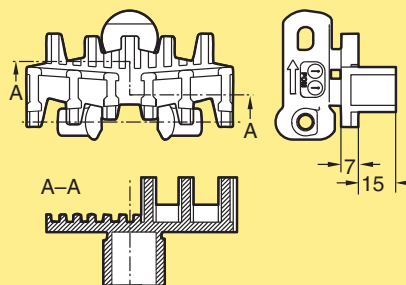
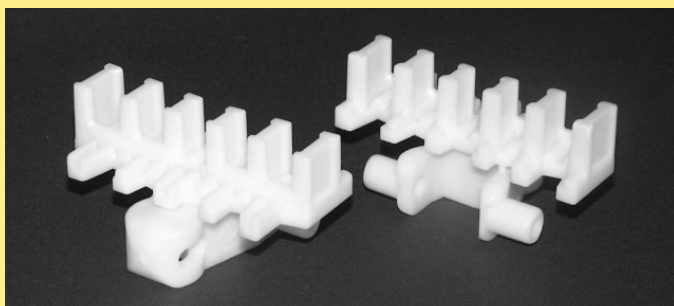

Chain	Config.	Link(s)	Link kit(s)	Dimensions	Link weight	Material, link	Material, pivot
5995239	PAR 1-20	5110400	5110563		42 g	POM A	PVDF
		5110394*	5110561				

*Link type between main cleat links.

Introduction
X45
X45H
XS
XL
X65
XM
X70X
X85
X85X
XH
XK
X180
X180X
X300
X300X
XT
XTC
WK
WL
WL 222X
WL 273X
WL 374X
WL 526X
WL 678X
ELV
IDX

Cleated chain

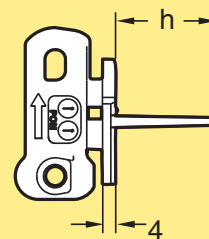
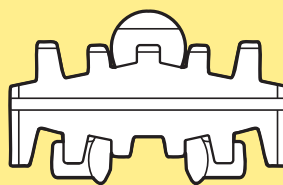
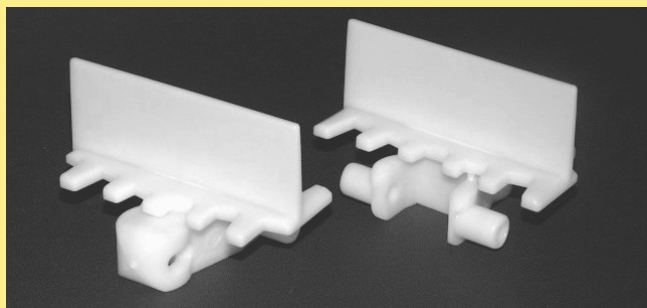

Vertical transport. Rectangular products, sensitive to point load.

Chain	Config.	Link(s)	Link kit(s)	Dimensions	Link weight	Material, link	Material, pivot
5995240	PAR 1-20	5110401 5110431*	5110564	h=15 mm	33 g	POM B	See page III
5995241	PAR 1-20	5110403 5110431*	5110565	h=20 mm	35 g	POM B	See page III
5995229	PAR 1-20	5105216 5110431*	5110566	h=30 mm	38 g	POM B	See page III

*Link type between main cleat links.

Cleated chain

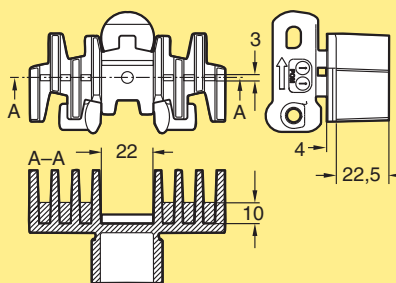
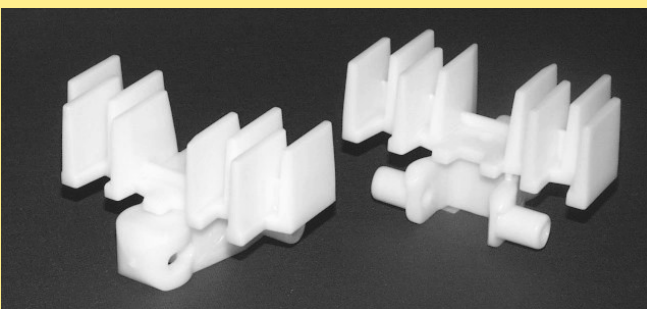

Wet applications.

Chain	Link(s)	Link kit(s)	Dimensions	Link weight	Material, link	Material, pivot
5110410	5110404	5110567			POM A	PVDF

Cleated chain

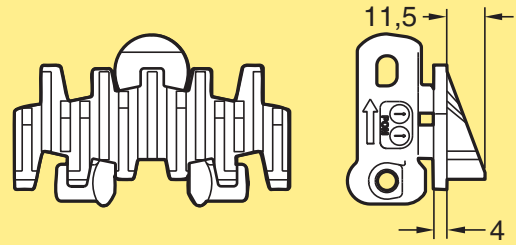
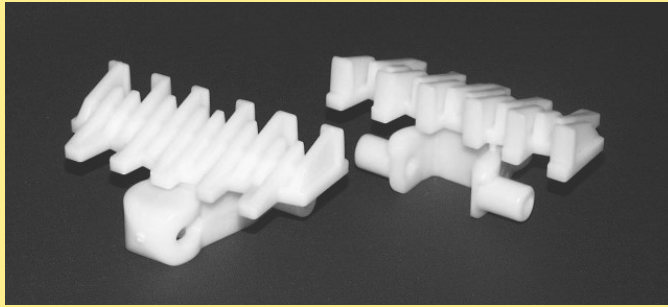

Cardboard boxes. Suitable to reduce accumulation forces in slopes (10°- 20°).

Chain	Config.	Link(s)	Link kit(s)	Dimensions	Link weight	Material, link	Material, pivot
5995243	PAR 1-20	5110413 5110431*	5110570		38 g	POM A	See page III

*Link type between main cleat links.

Cleated chain

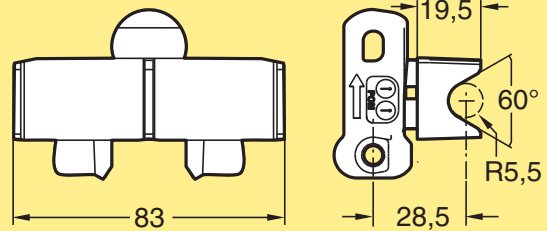
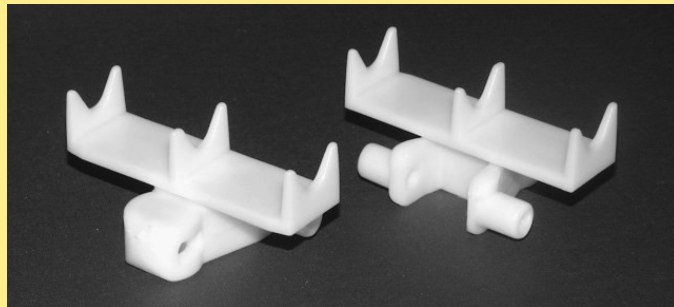

Tubes placed in cleat. Can not be used in horizontal bends.

Chain	Link(s)	Link kit(s)	Dimensions	Link weight	Material, link	Material, pivot
5110416	5110415	5110573		31 g	POM B	See page III

Cleated chain

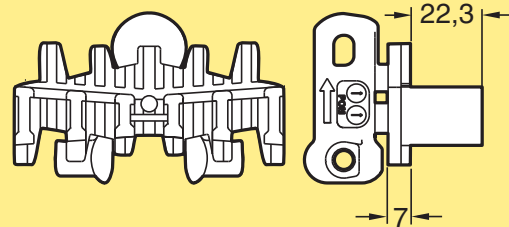
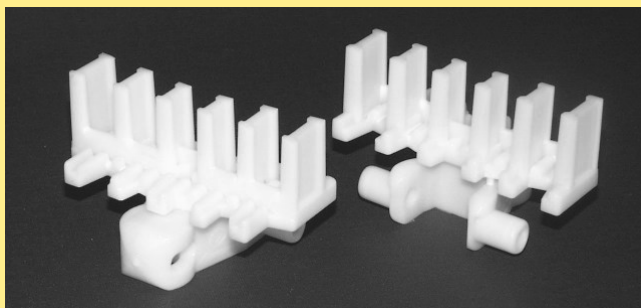

Wet applications.

Chain	Config.	Link(s)	Link kit(s)	Dimensions	Link weight	Material, link	Material, pivot
5995238	PAR 1-20	5110397 5110394*	5110562 5110561			POM A	PVDF

*Link type between main cleat links.

Cleated chain

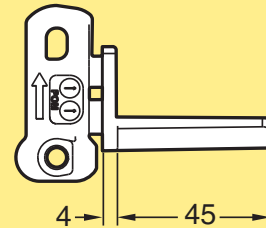
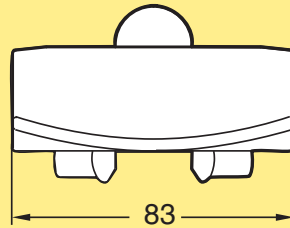
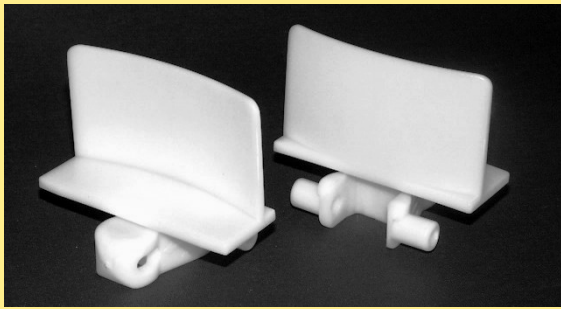

Minimum horizontal bend radius 700 mm.

Chain	Config.	Link(s)	Link kit(s)	Dimensions	Link weight	Material, link	Material, pivot
5995236	PAR 1-20	5110389 5110387*	5110575 5110576		45 g	POM B	See page III

*Link type between main cleat links.

Cleated chain

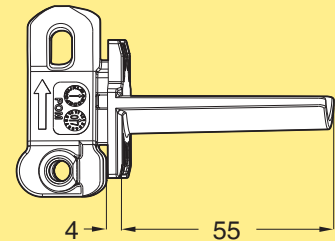
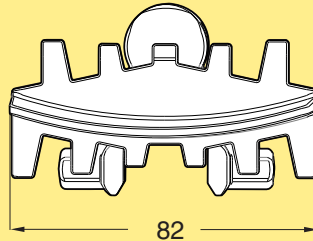

Large cleat that requires modified drive unit, or use direct drive.

Chain	Config.	Link(s)	Link kit(s)	Dimensions	Link weight	Material, link	Material, pivot
5995574	PAR 1-20	5112714 5110431*	5112716			POM B	See page III

*Link type between main cleat links.

Cleated chain

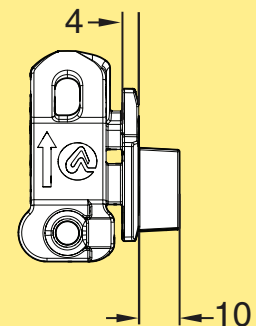
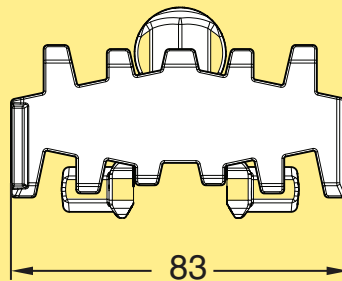
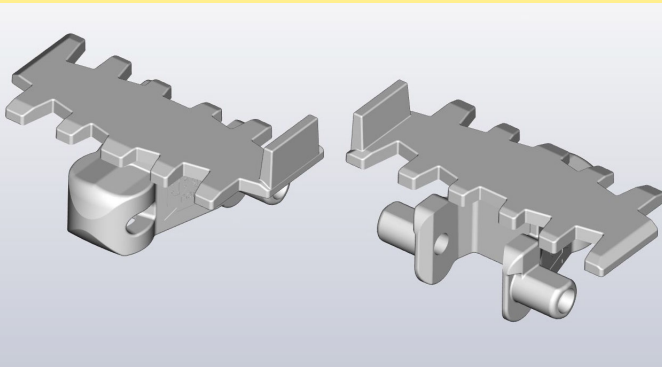

Chain	Link(s)	Link kit(s)	Dimensions	Link weight	Material, link	Material, pivot
FLX1005503	FLX1005078	FLX1005504			POM B	See page III

Flexible cleat chain

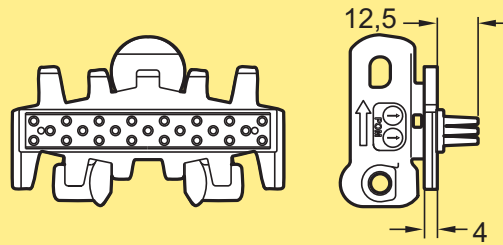
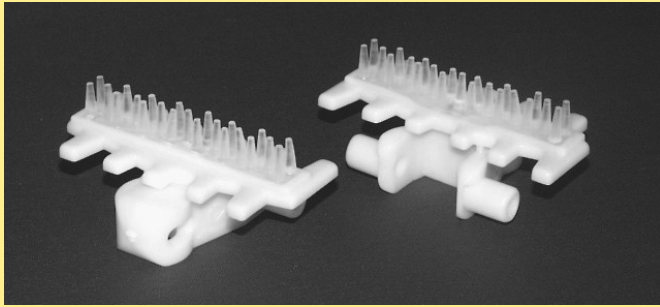

Wedge transport. Recommended for horizontal transport of light products e.g. paper bags, bottles and cans. Max. product weight: 3,0 kg. Flexible insert is polyether-polyamide.

Chain	Link(s)	Link kit(s)	Dimensions	Link weight	Material, link	Material, pivot
XBTE 5A85 B	5110461	5110522		31 g	POM B	See page III

Flexible cleat chain

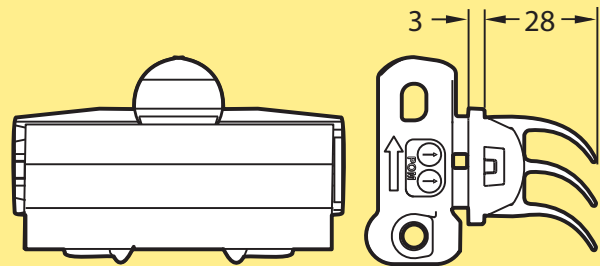
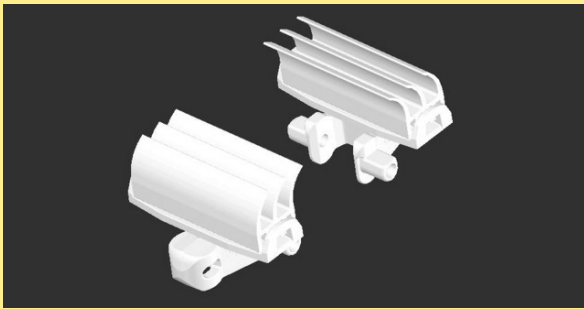

Wedge transport. Soft, flexible surface for sensitive items. Max product weight: 2,0 kg.

Flexible cleat is thermo-plastic elastomer.

Link kit 5110363: 10 base links incl flexible cleat top (5059812) + pivots + pins.

Link kit 5110515: 10 flexible cleat tops.

Chain	Link(s)	Link kit(s)	Dimensions	Link weight	Material, link	Material, pivot
XBTE 5A85 C	5059812	5110363		40 g	POM B	See page III
		5110515				

Introduction
X45
X45H
XS
XL
X65
XM
X70X
X85
X85X
XH
XK
X180
X180X
X300
X300X
XT
XTC
WK
WL
WL 222X
WL 273X
WL 374X
WL 526X
WL 678X
ELV
IDX

Flexible cleat chain

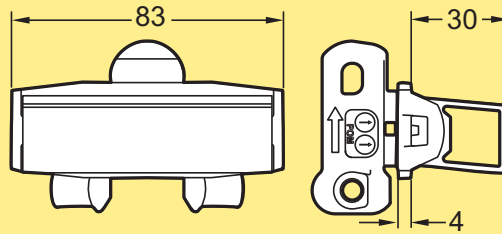
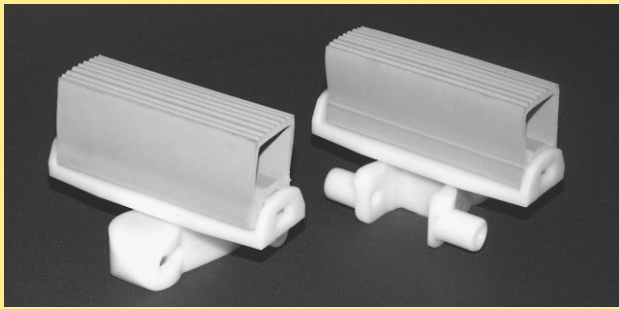

Wedge transport. Recommended for irregular shapes. Max. product weight for XMTE 5 D: 4,0 kg. Flexible cleat is EPDM rubber.

Link kit 5110582: 10 base links incl flexible cleat top (5110381) + pivots + pins.

Link kit 5056311: 10 flexible cleat tops.

Chain	Link(s)	Link kit(s)	Dimensions	Link weight	Material, link	Material, pivot
XBTE 5A85 D	5110381	5110582		66 g	POM B	See page III
		5056311				

Roller top chain

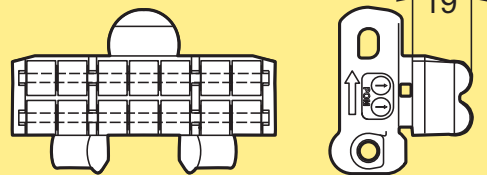
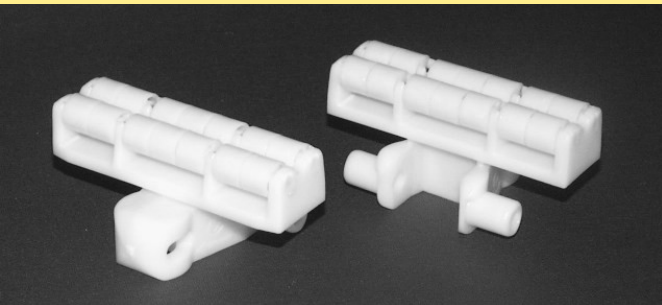

Accumulation of parcels for lower pressure. Link cannot be used together with plain links in conveyors with bends.

Chain	Link(s)	Link kit(s)	Dimensions	Link weight	Material, link	Material, pivot
XBTR 5A85	5110490	5110520		58 g	POM A/B	See page III
<i>(3902819 Roller, order in multiples of 200 Pcs)</i>						

Roller cleat chain

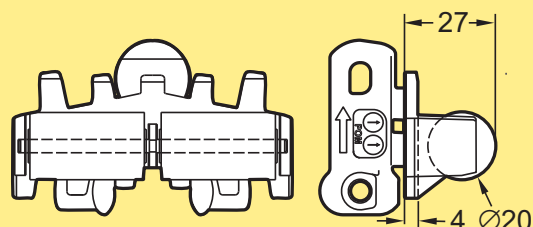
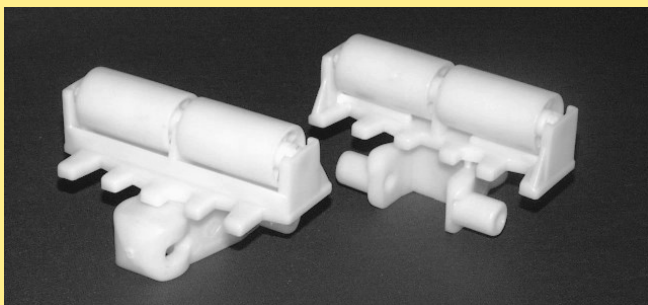

Accumulation of parcels for lower pressure. To be used for transport of e.g. cardboard boxes.

Chain	Config.	Link(s)	Link kit(s)	Dimensions	Link weight	Material, link	Material, pivot
XBTF 5A85X23 R	PAR 1-20	5110439 5110431*	5110521		59 g	POM A	See page III

**Link type between main cleat links.*

Roller cleat chain

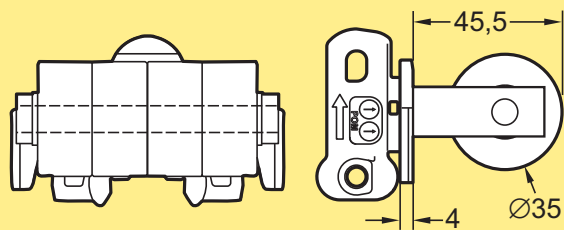
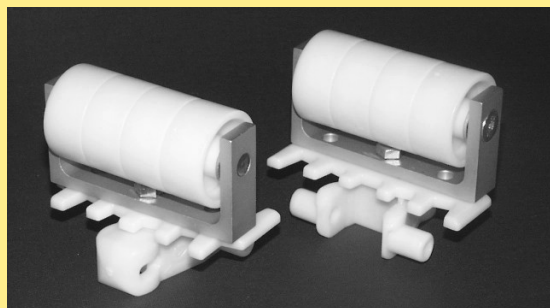

Roller support items in steel and aluminium. Vertical transport of cardboard boxes. Link kit 5110583: 1 link 5110481 with pivot and steel pin.

Chain	Config.	Link(s)	Link kit(s)	Dimensions	Link weight	Material, link	Material, pivot
XBTF 5A85X46 R	PAR 2-20	5110481 5110431*	5110583		143 g	POM A/B	See page III

*Link type between main cleat links.

V-block chain

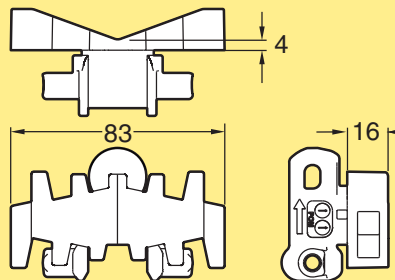
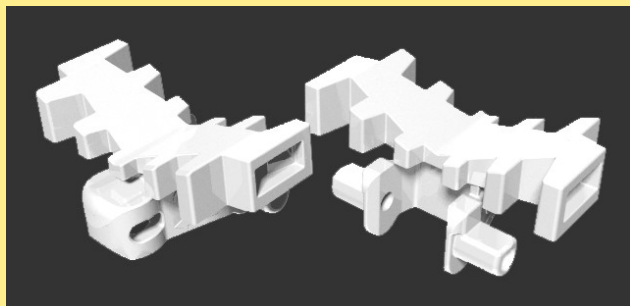

Chain	Link(s)	Link kit(s)	Dimensions	Link weight	Material, link	Material, pivot
5110386	5110385	5110577			POM A	See page III

