

Fasteners

Contents

Introduction513
Screws, bolts, locking lever of screw type.....514

Washers515
Nuts, locking lever of nut type.....515

Introduction

Slot nuts

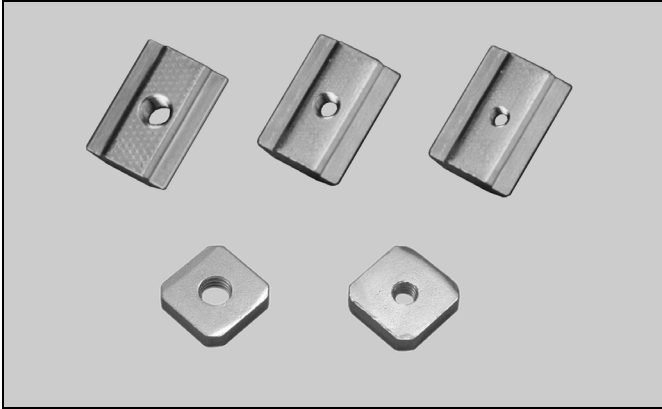

Slot nuts are used for connections to the structural system T-slots. The nuts exist in XC and XF versions.

Screws, nuts and washers



This catalogue lists a number of standard screws, nuts and washers which are needed frequently when building structural system applications.

Locking levers are recommended replacements for screws or nuts when frequent readjustment of a screw/nut connection are needed.

PO

CC

X45

XS

X65

X65P

X85

X85P

XH

XK

XKP

X180

X300

GR

CS

XT

HU

WL

WK

XC

XF

XD

ELV

SC

FST

TR

APX

IDX

Hex head bolt – ISO 4014/4017

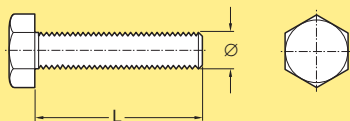

Hex head screw – ISO 4014/4017

M8, L=14 mm, Ø8 mm	M6S 8×14
M8, L=16 mm, Ø8 mm	M6S 8×16
M8, L=18 mm, Ø8 mm	M6S 8×18
M8, L=30 mm, Ø8 mm	M6S 8×30

Note. Contains 50 pcs.

Hex socket head cap screw, ISO 4762

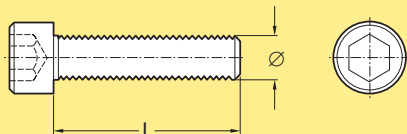

Hex socket head screws, standard
– DIN 912, ISO 4762

M5, L=12 mm, Ø5 mm	MC6S 5×12
M5, L=20 mm, Ø5 mm	MC6S 5×20
M5, L=35 mm, Ø5 mm	MC6S 5×35
M6, L=10 mm, Ø6 mm	5044478
M6, L=14 mm, Ø6 mm	MC6S 6×14
M6, L=16 mm, Ø6 mm	MC6S 6×16
M6, L=30 mm, Ø6 mm	MC6S 6×30
M6, L=50 mm, Ø6 mm	MC6S 6×50
M8, L=14 mm, Ø8 mm	MC6S 8×14
M8, L=30 mm, Ø8 mm	MC6S 8×30

Note. Contains 50 pcs.

Hex head cap screw, low head DIN 7984

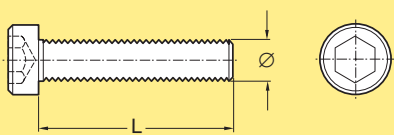

Hex socket head screw, low profile
– DIN 7984

M5, L= 8 mm, Ø5 mm	MLC6S 5×8
M5, L=10 mm, Ø 5 mm	MLC6S 5×10
M5, L=20 mm, Ø 5 mm	MLC6S 5×20
M6, L=12 mm, Ø 6 mm	MLC6S 6×12
M8, L=14 mm, Ø 8 mm	MLC6S 8×14
M8, L=30 mm, Ø 8 mm	MLC6S 8×30
M8, L=35 mm, Ø 8 mm	MLC6S 8×35

Note. Contains 50 pcs.

Hexagon socket countersunk head screw ISO 10642

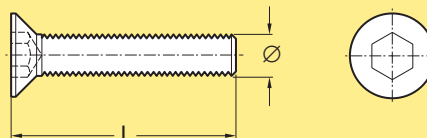

Hex socket head screw, countersunk
– DIN EN ISO 10642

M6, L=12 mm, Ø6 mm	MF6S 6×12
M6, L=14 mm, Ø6 mm	MF6S 6×14
M6, L=16 mm, Ø6 mm	MF6S 6×16
M6, L=30 mm, Ø6 mm	MF6S 6×30
M8, L=18 mm, Ø8 mm	MF6S 8×18
M8, L=30 mm, Ø8 mm	MF6S 8×30
M8, L=40 mm, Ø8 mm	MF6S 8×40

Note. Contains 50 pcs.

Selftapping screw, countersunk DIN 7500- ME

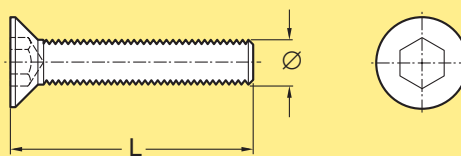

Selftapping screw
M8, L=30 mm, Ø8 mm
Countersunk

MF6S-TT 8×30

Note. Contains 50 pcs.

Selftapping screw, hex socket head DIN 7500- EE

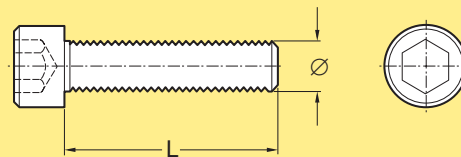

Selftapping screw
M6, L=30 mm, Ø6 mm
Hex socket head

MC6S-TT 6×30

Note. Contains 50 pcs.

T-bolt for conveyor beam

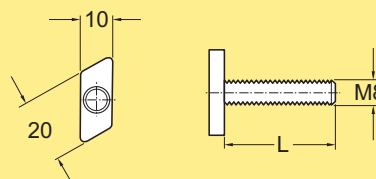

T-bolt M8

L= 17,8 mm	XLAT 17
L= 24 mm	XLAT 24
L= 35 mm	XLAT 35
L= 53 mm	XLAT 53
L= 71 mm	XLAT 71

Note. Contains 50 pcs.

Locking lever, screw type

Locking lever with M8 screw
Thread length 10 mm

XLAL 8x10

Washers

Washers

Flat washer

For M5, d=5,3 mm, D=10 mm	BRB 5.3x10
For M6, d=6,4 mm, D=12 mm	BRB 6.4x12
For M8, d=8,4 mm, D=16 mm	BRB 8.4x16

Note. Contains 50 pcs.

Nuts, locking lever of nut type

Nut for T-bolt DIN 985:1987 Class 8

Locking nut M8 for T-bolt

XLAN 8

Note. Contains 50 pcs.

Square nut for System XC T-slot

Square nut for XC
M8 thread
M6 thread

XLAQ 8
XLAQ 6

Note. Contains 50 pcs.

Nut – ISO 4032

M6 nut

M6M M6

Note. Contains 50 pcs.

T-slot nut for System XF T-slot

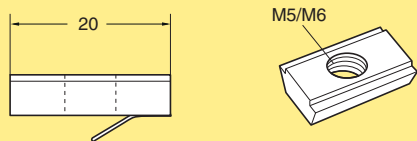

T-slot nut for XF

Steel, zinc-chromated

M5
M5, multipack (500 pcs)

M6
M6, multipack (500 pcs)

XFAN 5*

5056131

XFAN 6*

5056130

**Note. Contains 10 pcs.*

T-slot nut for System XC T-slot

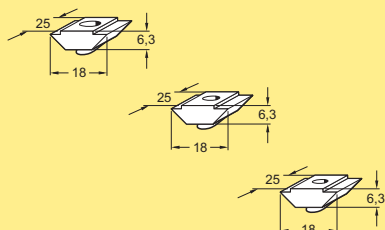

T-slot nut for XC

Steel, zinc-chromated

M5
M5, multipack (250 pcs)

M6
M6, multipack (250 pcs)

M8
M8, multipack (250 pcs)

XCAN 5*

5056129

XCAN 6*

5056128

XCAN 8*

5056127

**Note. Contains 10 pcs.*

Locking lever, nut type

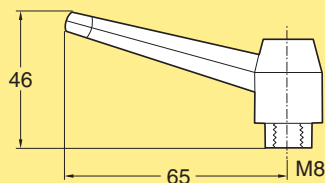

Locking lever with M8 thread

XLAL 8