

Conveyor system XS

Contents

System information.....	101	End drive units XS.....	109	
Conveyor modules.....	102	End drive units XS, direct drive with slip clutch.....	109	X45
Chains XS.....	103	Bend drive unit XS.....	109	XS
Chain accessories XS.....	104	Idle end unit XS.....	109	
Beam XS.....	105	Wheel bends XS.....	110	X65
Beam accessories XS.....	105	Plain bends XS.....	110	
Slide rails XS.....	106	Vertical bends XS.....	111	X65P
Drive and idler units – introduction.....	108	Front piece XS.....	113	

System information



Chain width 44 mm

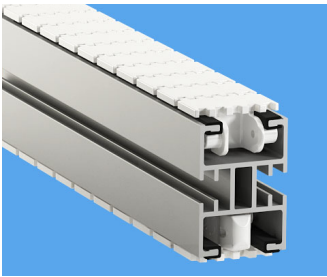

Features

Chain permits transport of very small items which are otherwise difficult to handle. Compact and neat design.

Examples of application areas

Small ball bearings, perfume bottles, pharmaceutical bottles, sintered metal components.

Technical characteristics

Drive unit capacity limit.....	500 N
Chain tension limit.....	500 N
Beam width.....	45 mm
Chain width.....	44 mm
Chain pitch.....	25,4 mm
Item width.....	10–80 mm
Maximum item weight	
Horizontal transport.....	2 kg
Vertical transport.....	1 kg
Maximum weight on conveyor.....	150 kg
Maximum conveyor length.....	30 m
Maximum permitted load per link	0,5 kg

Conveyor modules

Straight conveyor

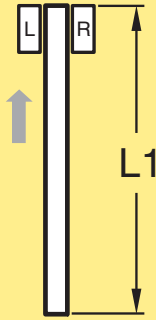

Conveyor module – straight * **5990226**

**Use online configurator when ordering*

One bend conveyor

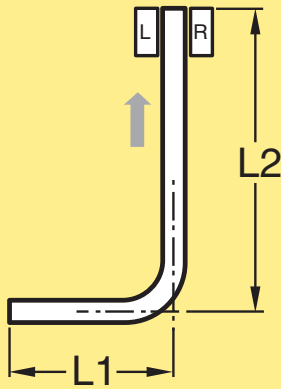

Conveyor module – one bend * **5990230**

**Use online configurator when ordering*



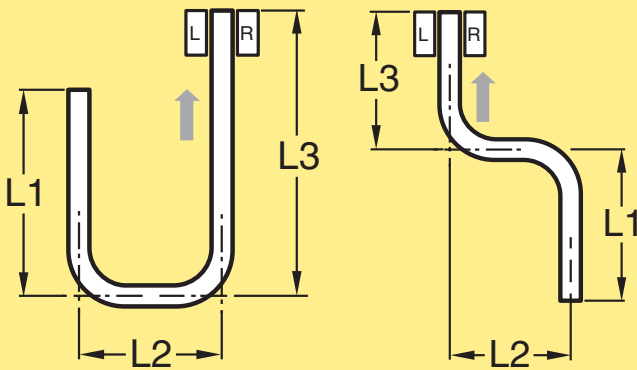







Two bend conveyor



Conveyor module – two bends * **5990237**

**Use online configurator when ordering*

Support modules – single and multi-lane

	5995387	Single diecast
	5995388	Single end adjustable
	5995389	Single end guide roller
	5995390	Single foot plate
	5995391	Single two/three-point
	5995393	Multi single 2 lane
	5995394	Multi single 3 lane
	5995395	Multi single 4 lane
	5995396	Multi double 2 lane
	5995397	Multi double 3 lane
	5995398	Multi double 4 lane

Plain chain

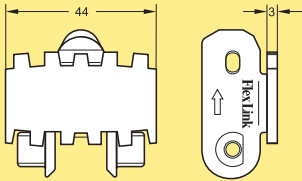

Plain chain
Length 5 m **XSTP 5**

Plain link kit **5056061**

Plain chain (Ultra low wear)
Length 5 m **XSTP 5 C**

Plain link kit (Ultra low wear) **n.a.**

Note. Link kit contains 10 links, 10 pivot, 10 steel pins.

Cleated chain, Type D

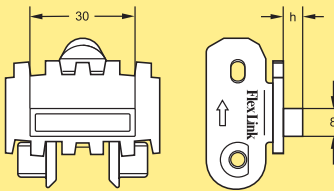

Cleated chain Type D,
Length 5 m

h=3 **XSTF 5x3 D**
h=5,5 **XSTF 5x5.5 D**
h=9 **XSTF 5x9 D**
h=27 **XSTF 5x27 D**

Use the online configurator to specify and order.

Cleated link kit

h=3 **5056052**
h=5,5 **5056049**
h=9 **5056045**
h=27 **5056053**

Note. Link kit contains 10 links, 10 pivot, 10 steel pins.

Cleated chain (flat top cleats)

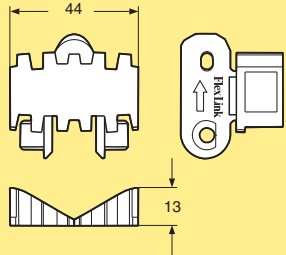

Cleated chain
Length 5 m **3903721**

Cleated link kit **5056626**

Note. Link kit contains 10 links, 10 pivot, 10 steel pins.

Other chains
See the Chain guide for selection of other chains.

Chain installation
See Appendix "D. Chain installation" on page 530,

Cleated chain, Type G

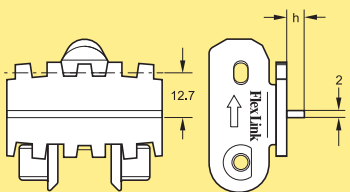

Cleated chain Type G
Length 5 m

h=3 **XSTF 5x3 G**
h=5 **XSTF 5x5 G**
h=9 **XSTF 5x9 G**

Use the online configurator to specify and order.

Cleated link kits

h=3 **5056051**
h=5 **5056050**
h=9 **5056043**

Note. Link kit contains 10 links, 10 pivot, 10 steel pins.

Steel top chain

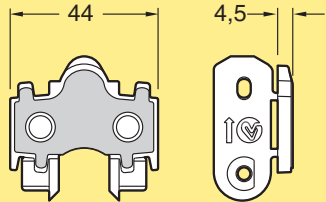

Steel top chain
Length 5 m **XSTP 5 TF**

Steel top link kit **5056634**

Note. Link kit contains 10 links, 10 pivot, 10 steel pins.

Other chains
See the Chain guide for a selection of other chains.

Chain installation
See "Appendix "D. Chain installation" on page 530 for installation instructions.

Chain accessories XS

Plastic pivot for chain



Plastic pivot kit XS

5111489

Plastic pivot kit, 25 pc

Steel pin

XLTD 4x36

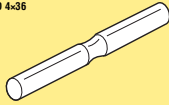

Steel pin kit XS

5111492

Steel pin kit, 25 pc

Pin insertion tool for chain

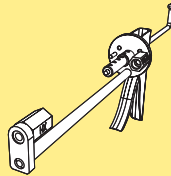
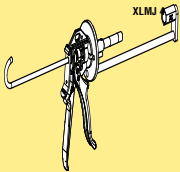

Pin insertion tool

XS-X65-XT

XS-X65-XT, PRO version*

XLMJ 4

XLMJ 4 P

**This product is recommended for frequent users.*

Conveyor beam

Beam
 Length 3000 +10/-0 mm
 Length to order (30- 3000 mm)

XSCB 3
XSCB L

Slide rail: see page 106

Beam accessories XS

Connecting strip with set screws

Connecting strip with set screws
 h=20, a=30, b=50, L=130

XSCJ 6x130

Note. Contains 10 pcs.

Cover strip for T-slot, PVC

Cover strip for T-slot, PVC
 Length 25 m

XLAB 25

For XS-XH

Beam spacer

XS	X65	X85/XH	XK
h=16,0 mm	h=15,9 mm	h=10,5 mm	h=0,5 mm

Beam spacer
 Aluminium, anodized
 Length 3 m

XLCD 3

For connection of two conveyor beams side to side. Use M8 screw and slot nut. Two holes must be drilled, one through the spacer (9 mm) and one through the beam, to allow insertion of the screw. The diameter of the second hole depends on the size of the screw head.

Slide rails XS

Plastic slide rails for XS beam

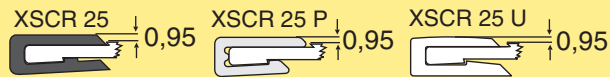

Slide rail

Length 25 m

HDPE ($\mu=0,1-0,25$) (Black)

PVDF ($\mu=0,15-0,35$) (Natural white)

UHMW-PE ($\mu=0,1-0,25$) (White)

PA-PE ($\mu=0,1-0,25$) (Grey)

XSCR 25

XSCR 25 P

XSCR 25 U

XSCR 25 H

Aluminium rivets

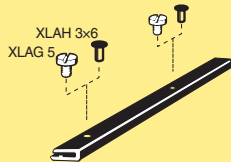

Aluminium rivets 3 mm for XS conveyors

XLAH 3x6

Extra slide rail in plain bends must be anchored using plastic screws due to lack of space for the rivet crimping tool.

Note. Contains 250 pcs..

Mounting tool for slide rail



Mounting tool for slide rail XS, X65 **XLMR 140**

Drill fixture for slide rail

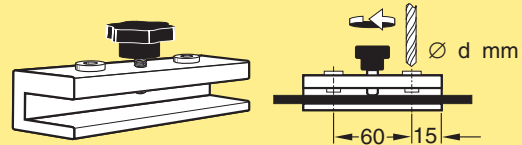

Drill fixture for XS slide rail
d=3,2

3924774

Rivet crimping pliers



Rivet crimping pliers for XS
For 3 mm rivets

3924776

Toolbox for assembly and maintenance (XS, X65, XL)

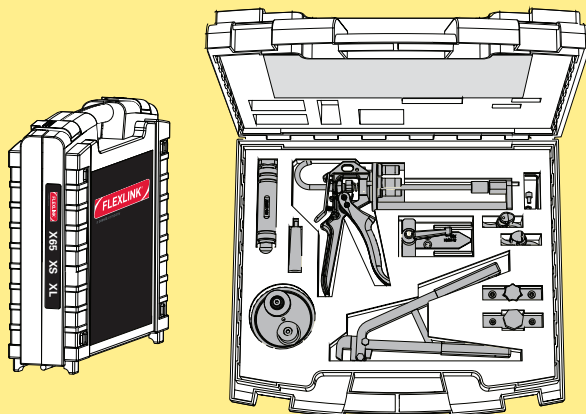

Toolbox

FLX1007253

Contains:

Pin insertion tool (chain)

Mounting tool (slide rail)

Mounting tool handle* (slide rail)

Rivet crimping pliers 4 mm (slide rail)

Pliers kit 3 mm (slide rail)

Rivet crimping clamp 4 mm (slide rail)

Rivet tool 3 mm (slide rail)

Drill fixture (slide rail)

Drill fixture 4 mm (slide rail)

Drill fixture 3 mm (slide rail)

XLMJ 4 P

XLMR 140

3923686

5051395

3922995,

3922996

3923005

FLX1005029

5116761

3920500

3924774

Rivet crimping clamp

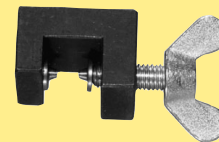

Rivet crimping clamp for XS
For 3 mm rivets

FLX1005029

Cover strip

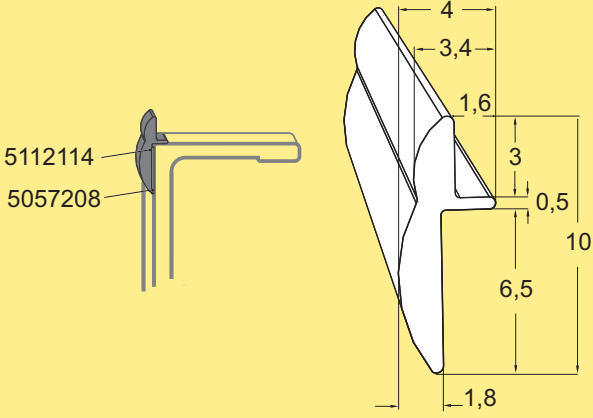

5112114
5057208

Cover strip
Length: 3 m
Material: Plastic PA 12 **5112114**

Cover the opening on the side between the chain and beam. Primarily for straight sections and the outer curves, but can also be mounted on inner curves. Apply using a double-sided tape, see mounting instruction 5497EN in Technical library.

Glue tape 3M



Glue tape
Length 30 m **5057208**

Drive unit types

The XS system includes several configurations, including direct driven units with suspended motor and transmission chain as well as drive units.

Available motors include variable speed types (**V**) as well as fixed speed motors (**F**).

End drive units

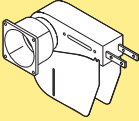
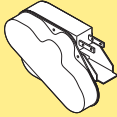
Size	Direct drive, slip clutch	Suspended motor, transmission chain, slip clutch
		
Heavy	F, V	F

Wheel bend drive units

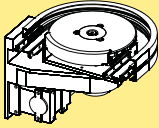
Size	Suspended motor, transmission chain, slip clutch
	
Heavy	F

Double drive units

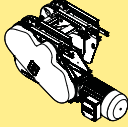
Size	Suspended motor, transmission chain, slip clutch
	
Heavy	F

Motor specifications

Motors are available for 230/400 V, 50 Hz and 230/460 V, 60 Hz. Variable speed motors are SEW Movimot, 380–500 V. Note that variable speed motors include a control box that adds 120 mm to the width of the motor.

IP55 available with standard oil.

IP65 available with food grade oil.

Ordering information

Drive units with motors must be specified using the web-based configurator. The configurator provides detailed information and step-by-step guidance in the specification process. A product code string is generated, containing the specification details. See next page for examples of code strings.

Drive units *without* motors can be ordered using the designations in the catalogue.

Dimension

Note that dimensions relating to drive unit motors depend on the motor specified during the configuration.

End drive unit, suspended motor, slip clutch

End drive unit
 Fixed speed up to 60 m/min
 Transmission on left side
 Fixed speed
 Without motor (ISO) **XSEB**
 Without motor (ANSI) **XSEB 0 HL**
XSEB 0 HLA

Maximum traction force: 500 N. See page 22.
 Use online configurator when ordering.
 Effective track length: 0,80 m

End drive unit, suspended motor, slip clutch

End drive unit
 Fixed speed up to 60 m/min
 Transmission on right side
 Fixed speed
 Without motor (ISO) **XSEB**
 Without motor (ANSI) **XSEB 0 HR**
XSEB 0 HRA

Maximum traction force: 500 N. See page 22.
 Use online configurator when ordering.
 Effective track length: 0,80 m

End drive units XS, direct drive with slip clutch

End drive unit, direct drive with slip clutch

End drive unit, direct drive
 Fixed speed up to 60 m/min
 Variable speed: see *Drive Unit Guide*
 Motor on left side **XSEB**
 Fixed/variable speed **XSEB 0 HLP**
 Motor on right side **XSEB**
 Fixed/variable speed **XSEB 0 HRP**
 Without motor

Maximum traction force: 500 N. See page 22.
 Use online configurator when ordering.
 Effective track length: 0,80 m

Bend drive unit XS

Bend drive unit, suspended, 180°

Bend drive unit, 180°
 Fixed speed up to 30 m/min
 Fixed speed
 Without motor (ISO) **XSEW**
 Without motor (ANSI) **XSEW 180/0 H**
XSEW 180/0 HA

Maximum traction force: 200 N. See page 22.
 Use online configurator when ordering.
 Effective track length: 0,65 m

Idler end unit XS

Idler end unit

Idler end unit **XSEJ 200**

Effective track length: 0,50 m

Wheel bends XS

Wheel bend, 30°

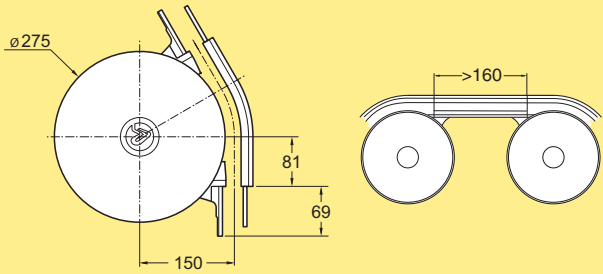

Wheel bend, 30° **XSBH 30R150 A**
Effective track length: 0,25 m 1-way (0,50 m 2-way)

Wheel bend, 90°

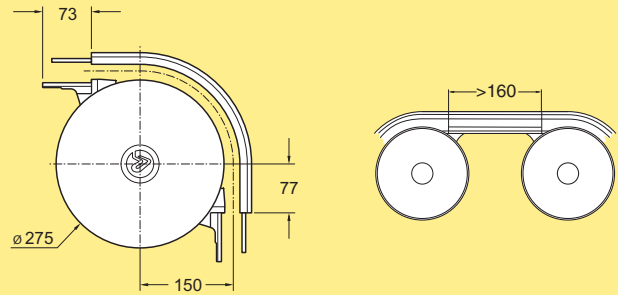

Wheel bend, 90° **XSBH 90R150 A**
Effective track length: 0,40 m 1-way (0,80 m 2-way)

Wheel bend, 45°

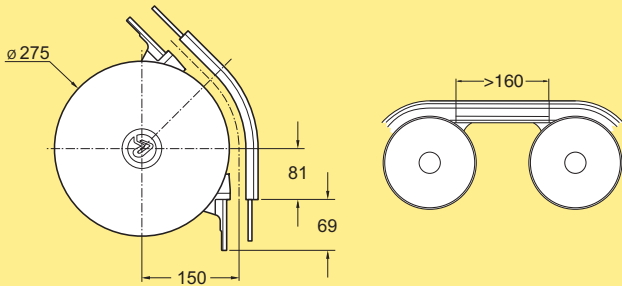

Wheel bend, 45° **XSBH 45R150 A**
Effective track length: 0,30 m 1-way (0,60 m 2-way)

Wheel bend, 180°

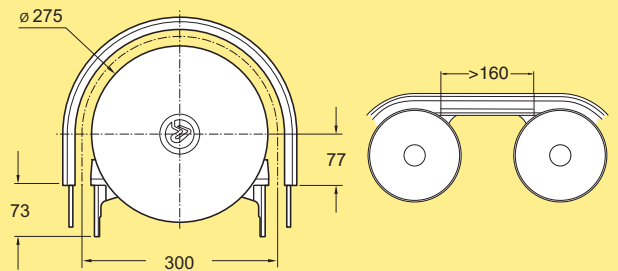

Wheel bend, 180° **XSBH 180R150 A**
Effective track length: 0,65 m 1-way (1,30 m 2-way)

Plain bends XS

Plain bend, 30°

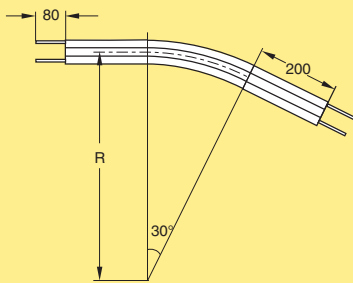

Plain bend, 30°±1°
R=500±10 mm **XSBP 30R500**
R=700±10 mm **XSBP 30R700**
R=1000±10 mm **XSBP 30R1000**

Effective track lengths:
R500: 0,70 m 1-way (1,35 m 2-way)
R700: 0,80 m 1-way (1,55 m 2-way)
R1000: 0,95 m 1-way (1,85 m 2-way)

Plain bend, 45°

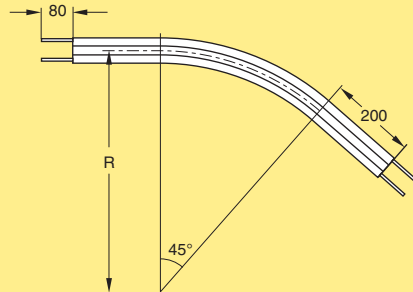

Plain bend, 45°±1°
R=500±10 mm **XSBP 45R500**
R=700±10 mm **XSBP 45R700**
R=1000±10 mm **XSBP 45R1000**

Effective track lengths:
R500: 0,80 m 1-way (1,60 m 2-way)
R700: 0,95 m 1-way (1,90 m 2-way)
R1000: 1,20 m 1-way (2,40 m 2-way)

Plain bend, 60°

Plain bend, 60°±1°
 R=500±10 mm
 R=700±10 mm
 R=1000±10 mm

XSBP 60R500
XSBP 60R700
XSBP 60R1000

Effective track lengths:
 R500: 0,95 m 1-way (1,85 m 2-way)
 R700: 1,15 m 1-way (2,30 m 2-way)
 R1000: 1,45 m 1-way (2,90 m 2-way)

Plain bend, 90°

Plain bend, 90°±1°
 R=500±10 mm
 R=700±10 mm
 R=1000±10 mm

XSBP 90R500
XSBP 90R700
XSBP 90R1000

Effective track lengths:
 R500: 1,20 m 1-way (2,40 m 2-way)
 R700: 1,50 m 1-way (3,00 m 2-way)
 R1000: 2,00 m 1-way (3,95 m 2-way)

Vertical bends XS

Vertical bend, 5°

Vertical bend, 5°
Effective track length: 0,20 m 1-way (0,40 m 2-way)

XSBV 5R300

Vertical bend, 30°

Vertical bend, 30°
Effective track length: 0,35 m 1-way (0,65 m 2-way)

XSBV 30R300

Vertical bend, 7°

Vertical bend, 7°
Effective track length: 0,22 m 1-way (0,44 m 2-way)

XSBV 7R300

Vertical bend, 45°

Vertical bend, 45°
Effective track length: 0,45 m 1-way (0,80 m 2-way)

XSBV 45R300

Vertical bend, 60°

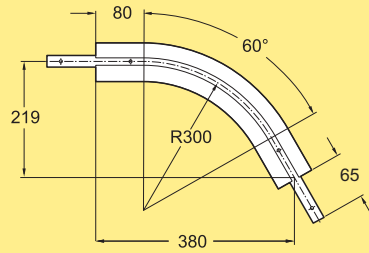

Vertical bend, 60° **XSBV 60R300**
 Effective track length: 0,50 m 1-way (0,95 m 2-way)

Vertical bend 90°

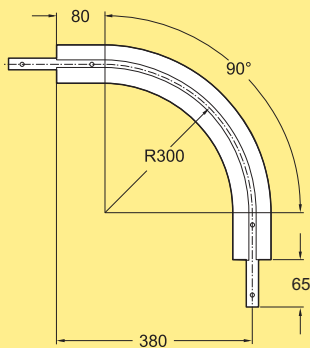

Vertical bend
 90° ± 0,5° **XSBV 90R300**
 R300 ± 5 mm
 Effective track length: 0,70 m 1-way (1,30 m 2-way)

Vertical bend, 5°–90°

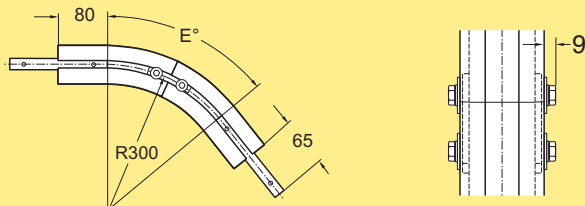

Vertical bend, 5°–90° **XSBV ER300**
 The bend is cut in the middle to the desired angle and assembled using connecting strips. The angle "E" must be specified when ordering.

Front piece

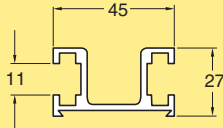

Front piece
Length 3 m

XSVF 3

Sliding strip for front piece

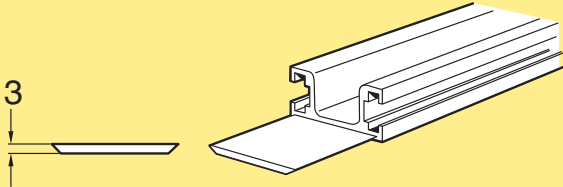

Sliding strip for front piece
Length 2 m

XSVG 2

*The sliding strip must be anchored to the front piece.
Rivets and tools for anchoring: see page 106.*

Bend support for front piece

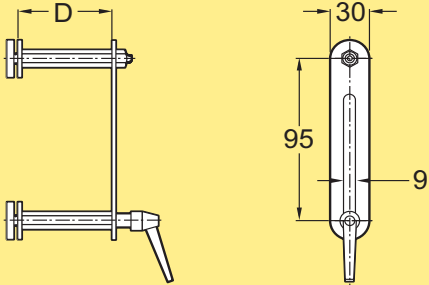

Bend support
D=33
D=58

**XLVS 33
XLVS 58**

Front piece upper bend

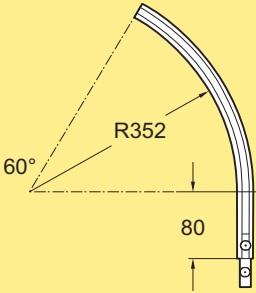

Upper bend, 60°

XSVA 60R352

Includes connecting strip with screws

Front piece lower bend

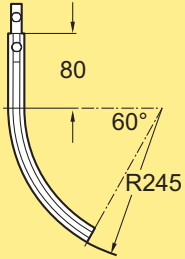

Lower bend, 60°

XSVB 60R245

Includes connecting strip with screws

Linkage kit for front piece

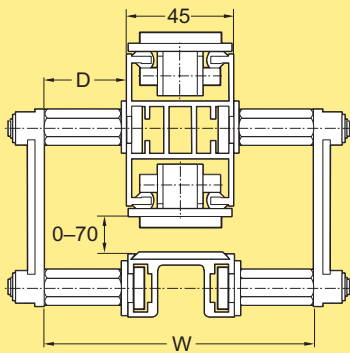

Linkage kit
W=110, D=33
W=160, D=58

**XLVK 33
XLVK 58**

Kit includes two support pairs and one locking device.

