



FlexLink®

Control box

5057310-02



Electrical supply

Main

Voltage	460-480 V (AC)
Phases	3
Frequency	60 Hz
Current	4 A
Short-circuit capacity	200kA

Controls

Fieldbus interface/cables	Application dependent
Physical space	150 x 220 mm (H x W)

Control method

Control objects (see sheet 312):

- Contactor K31203, 24V_{DC}-coil, Power consumption 4.5 W
- Contactor K31204, 24V_{DC}-coil, Power consumption 4.5 W

Each contactor has one control wire connected. One 0V_{DC}-wire is connected to one contactor and bridged over to the second. Totally three wires shall be connected to the communication device selected by the integrator.

Hardwired control

Equipment:

- 3 feed-through terminals 2.5 mm²

Connect wires Q44002, Q44005 and 200L- to terminals.

Fieldbus control

Equipment:

- Fieldbus interface with two digital inputs
(-Digital inputs for feedback functionality)

Connect wires Q44002, Q44005 and 200L- to output module terminals.

Drawings

	1	2	3	4	5	6	7	8
A	Index 100		Layouts 101 102			Circuit diagrams 301 310 311 312		External connections 510 511
B			Cabinet builder layouts 111 112 113 114 115 116					
C								
D								
E								

Nr:	Date	Sign	Change		Department FlexLink	Drawing No. 5057310		
							Customer	
							Drawn FJN Project No. 7220283 Date 06-03-29	Name Index -
						Sheet 100 Next 101		

01. Q30102

- 10. F31002
- 11. F31003
- 12. F31004
- 13. F31005
- 14. F31006
- 15. F31007
- 16. X110
- 17. X120
- 18. X31006

- 20. T31103
- 21. T31105
- 22. Q31103
- 23. Q31105
- 24. K31104
- 25. K31106
- 26. X31103
- 27. X31104
- 28. F31104
- 29. F31106

- 31. K31203
- 32. K31204

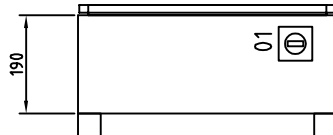
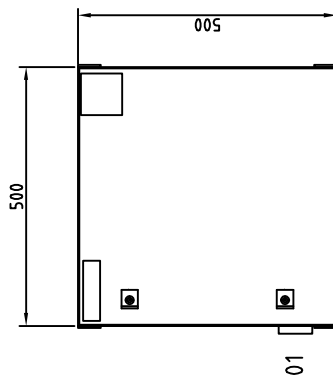
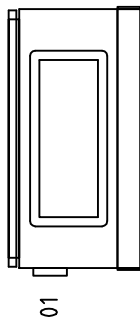

Nr.	Date	Sign	Change

Department FlexLink	
Customer	-
Drawn	FJN
Project No.	7220283
Date	06-03-29
Name	Layout, Exterior

Drawing No.	
5057310	
Sheet	101
Next	102

01. Q30102

- 10. F31002
- 11. F31003
- 12. F31004
- 13. F31005
- 14. F31006
- 15. F31007
- 16. X110
- 17. X120
- 18. X31006

- 20. T31103
- 21. T31105
- 22. Q31103
- 23. Q31105
- 24. K31104
- 25. K31106
- 26. X31103
- 27. X31104
- 28. F31104
- 29. F31106

- 31. K31203
- 32. K31204

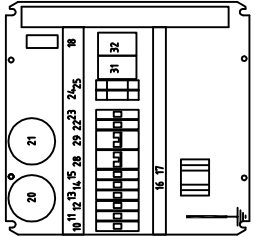
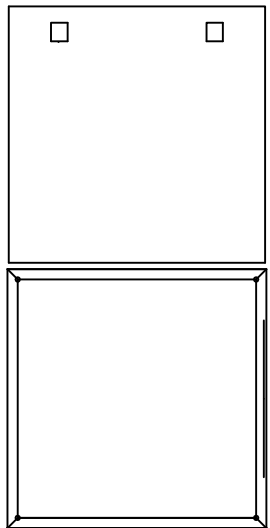

Nr.	Date	Sign	Change



Department	FlexLink
Customer	-
Drawn	FJIN
Project No.	7220283
Date	06-03-29

Department	FlexLink	Drawing No.	5057310
Customer	-	Name	Layout, Interior
Drawn	FJIN	Sheet	102
Project No.	7220283	Next	111
Date	06-03-29		

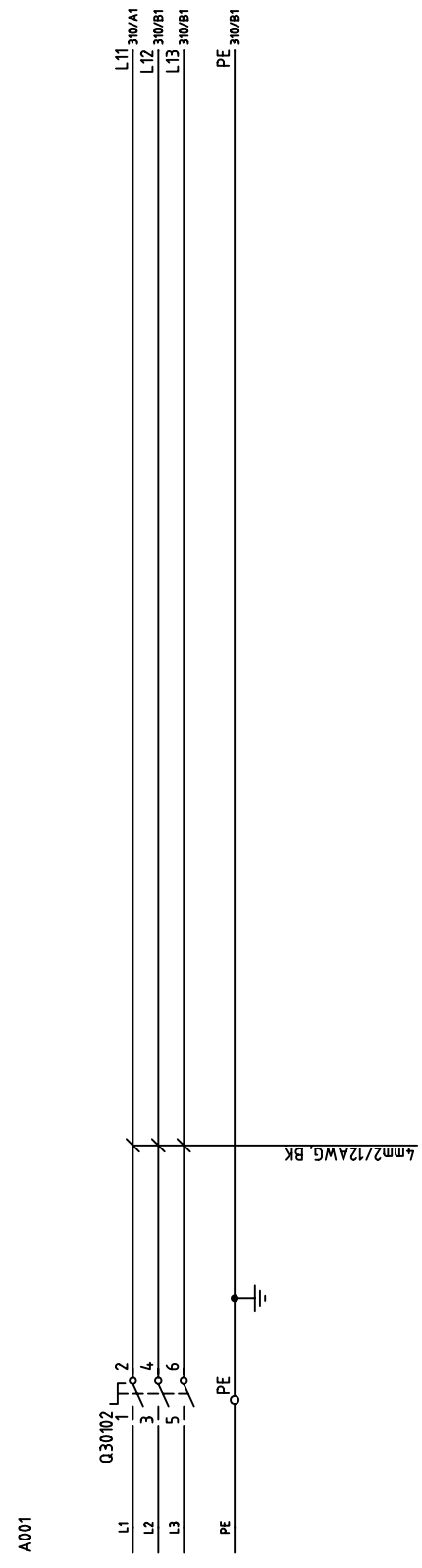

Where nothing else is said: 0.75mm²/20AWG

Identification of wiring	
Earth conductors	GREEN-AND-YELLOW
Neutral conductors	BLUE
AC or DC power conductors	BLACK
AC control circuits	RED
DC control circuits	BLUE
Interlocking control circuits supplied from external power	ORANGE

Nr.	Date	Sign	Change		Department FlexLink	Drawing No. 5057310
				Customer	-	
				Drawn	FJN	Project No. 7220283
				Appr.		Date 06-03-29
						Name Incoming supply
						Sheet 301
						Next 310

1 2 3 4 5 6 7 8

A B C D E F

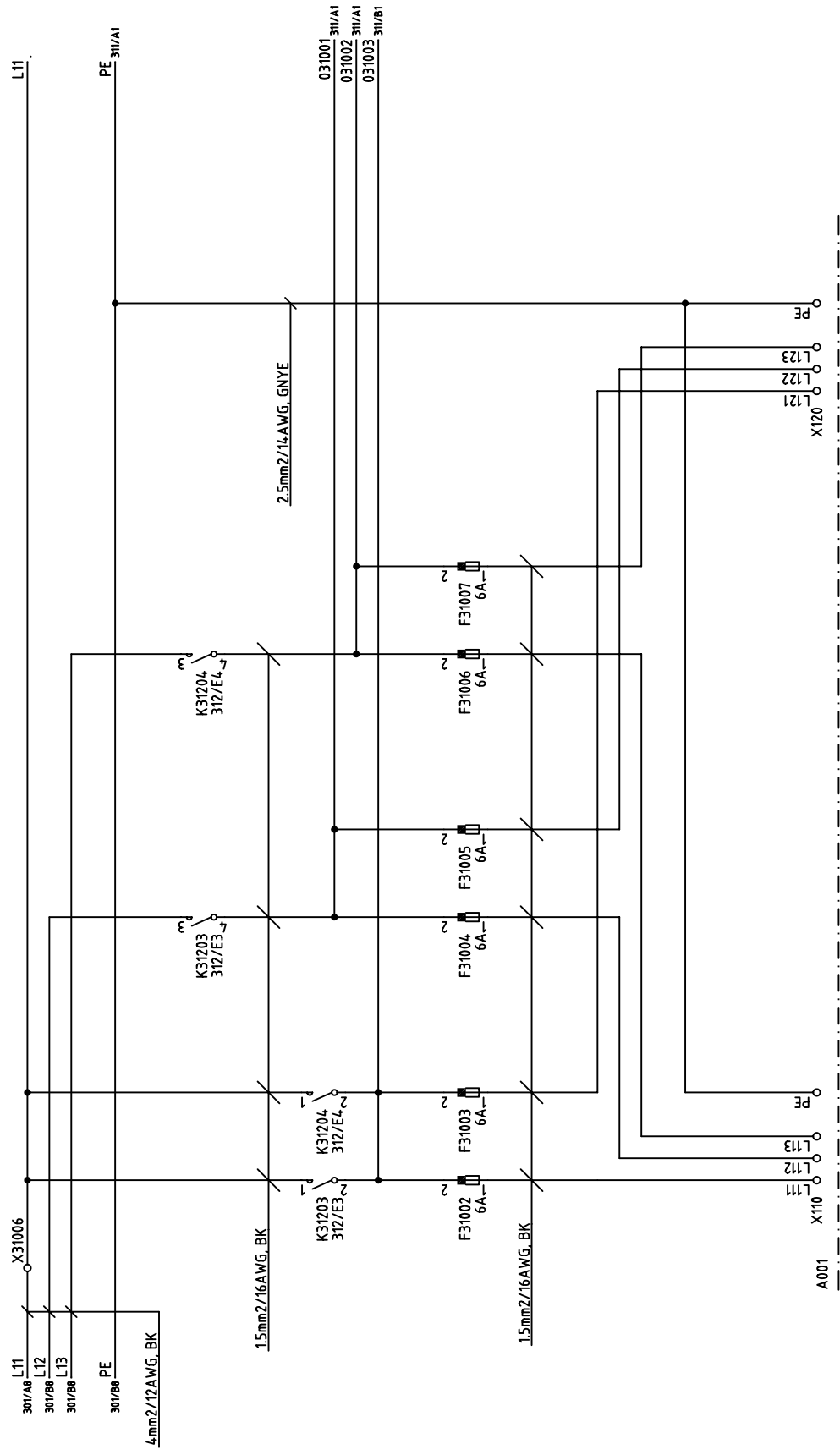

Denna ritning är FlexLink egendom. Skyddad enligt gällande lag.
 This drawing is the property of FlexLink. Protected in accordance with prevailing law.

No.	Date	Sign	Change



Department FlexLink	
Customer -	
Drawn FJN	Project No. 7220283
Appr.	Date 06-03-29
Name Zone supply	

Drawing No. 5057310	
Sheet 310	Next 311

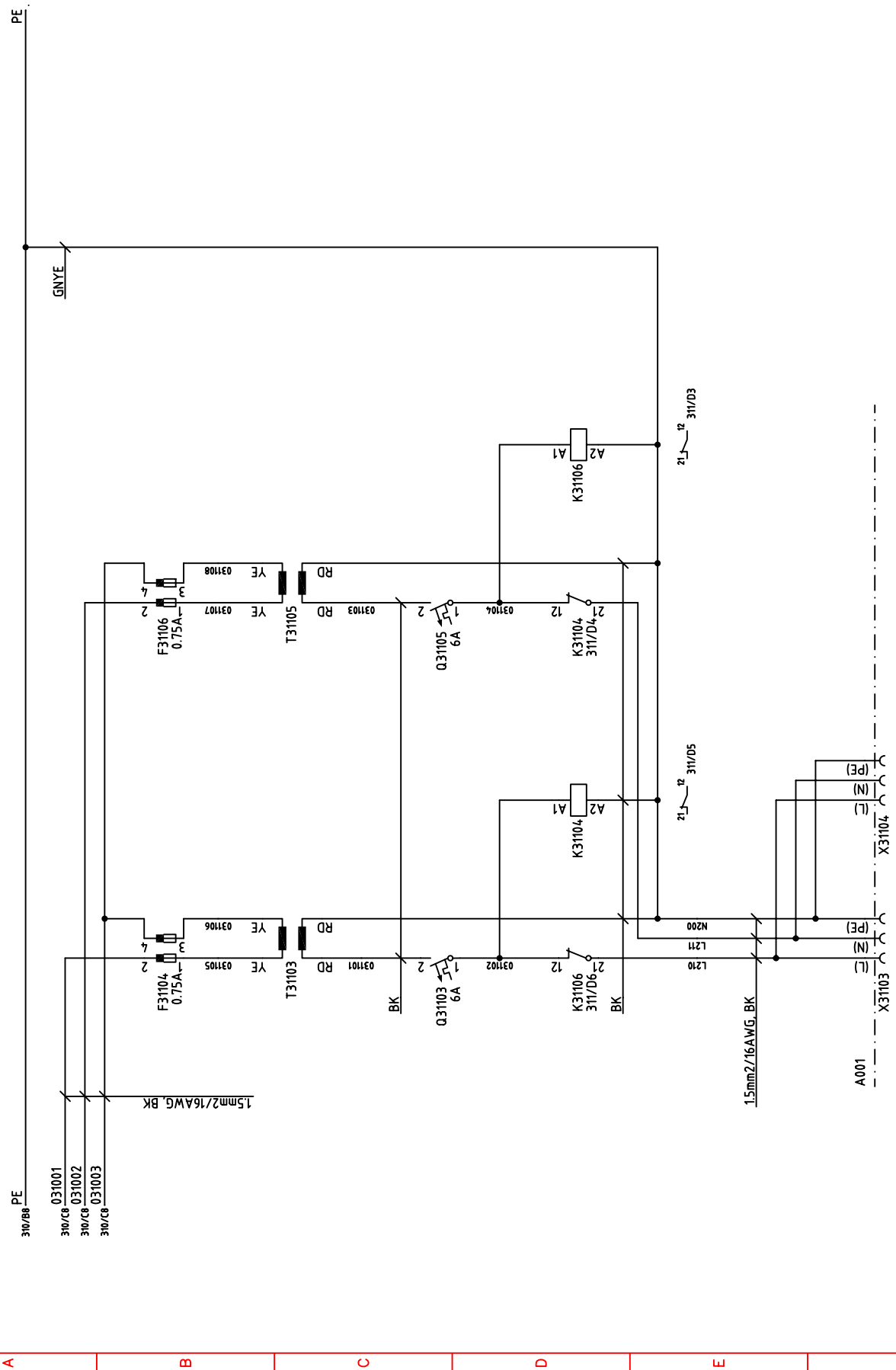

310/88 PE
 031001
 310/CB 031002
 310/CB 031003
 310/CB 031003

15mm2/16AWG, BK

310/88 PE
 GNYE

F31104 0.75A
 F31106 0.75A
 T31103
 T31104
 T31105
 T31106

0.31103 6A
 0.31105 6A

K31106 311/D6
 K31104 311/D4

1.5mm2/16AWG, BK

X31103
 X31104

311/D5
 311/D3

A001

No.	Date	Sign	Change



Department	FlexLink
Customer	-
Drawn	FJN
Project No.	7220283
Date	06-03-29
Name	Branch supply
Appr.	-

Drawing No.	5057310
Sheet	311
Next	312

1 2 3 4 5 6 7 8

A B C D E F

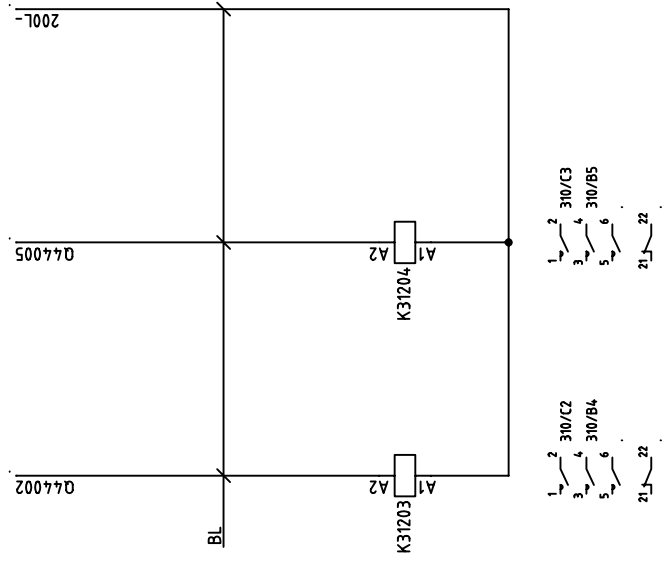

Denna ritning är FlexLink egendom. Skyddad enligt gällande lag.
 This drawing is the property of FlexLink. Protected in
 accordance with prevailing law.

Nr.	Date	Sign	Change			Department FlexLink Customer -		Drawing No. 5057310	
						Drawn FJN Appr.	Project No. 7220283 Date 06-03-29	Name Contactor control -	Sheet 312 Next 510

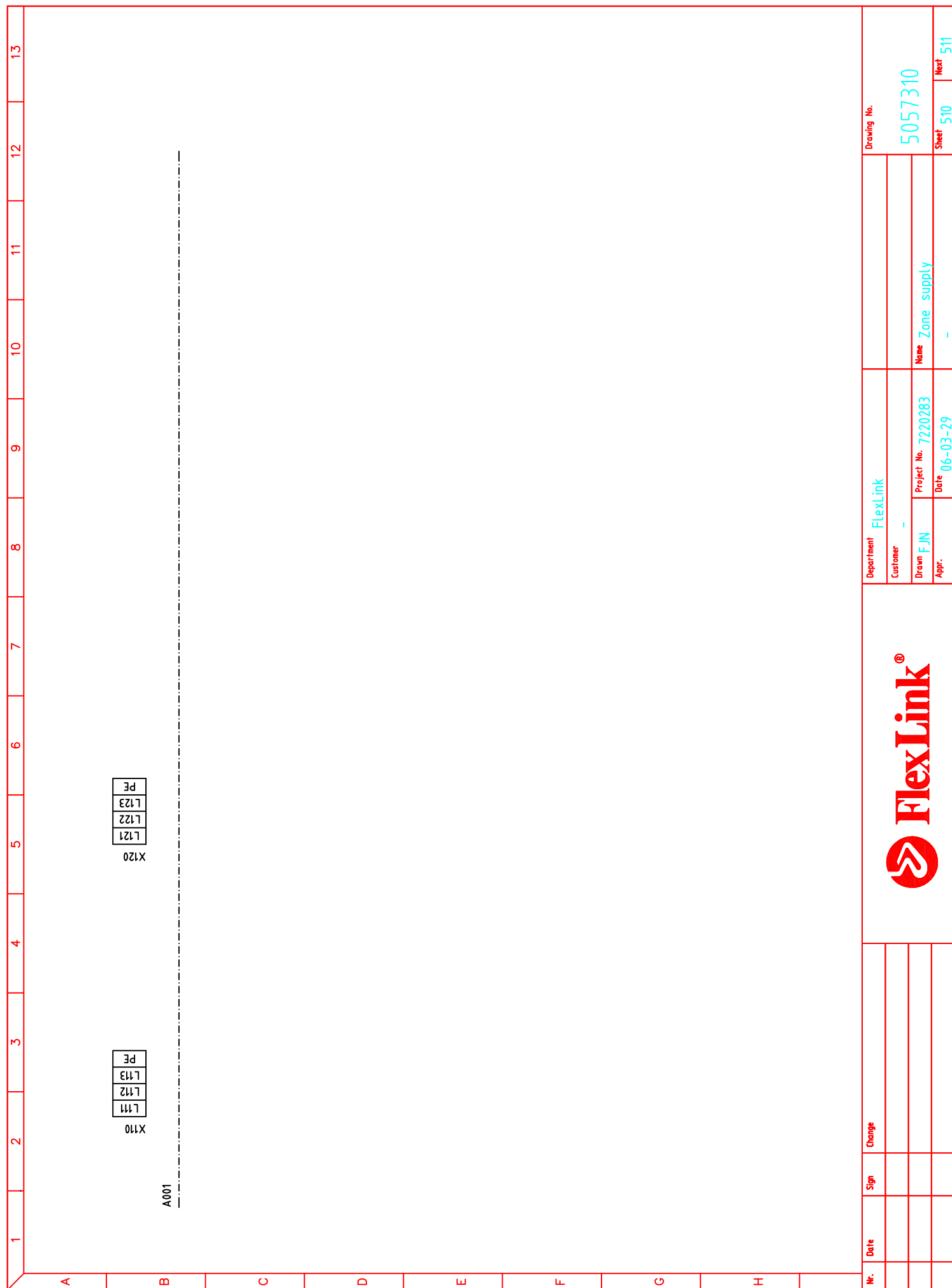

Drawing No.	5057310
Sheet	510
Next	511

Department FlexLink	
Customer	-
Drawn FJN	Project No. 7220283
Appr.	Date 06-03-29
Name	Zone supply

Nr.	Date	Sign	Change



1 2 3 4 5 6 7 8

A

B

C

D

E

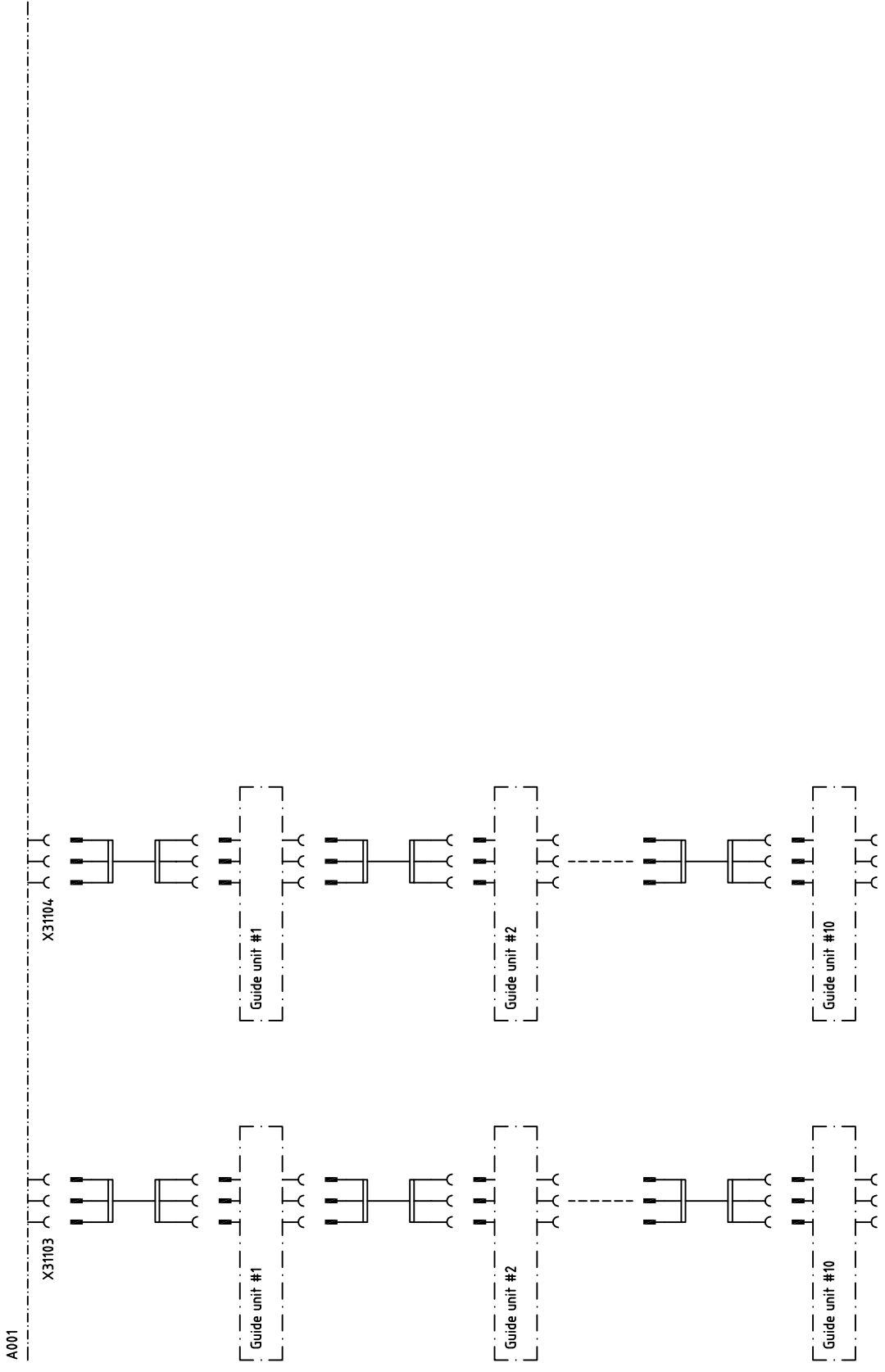

Nr.	Date	Sign	Change



Department	FlexLink
Customer	-
Drawn	FJN
Project No.	7220283
Date	06-03-29
Name	Branch supply
Appr.	-

Drawing No.	5057310
Sheet	511
Next	-