

# Structural system XD

## Contents

|                         |     |  |     |      |
|-------------------------|-----|--|-----|------|
| System information..... | 497 | Enclosure profiles.....                    | 499 |      |
| Beams XD .....          | 498 | Enclosure strips .....                     | 500 | X45  |
| Support beams.....      | 498 | Multiblock .....                           | 500 | XS   |
| Cover strip.....        | 498 | Door accessories.....                      | 500 | X65  |
| Angle brackets.....     | 498 | Components for XD doors in XD frames ..... | 500 | X65P |
| Connecting strips ..... | 498 | Components for XD doors in XC frames ..... | 500 | X85  |
| T-slot nut.....         | 499 |  |     | X85P |
| Adjustable feet.....    | 499 |  |     | XH   |

## System information

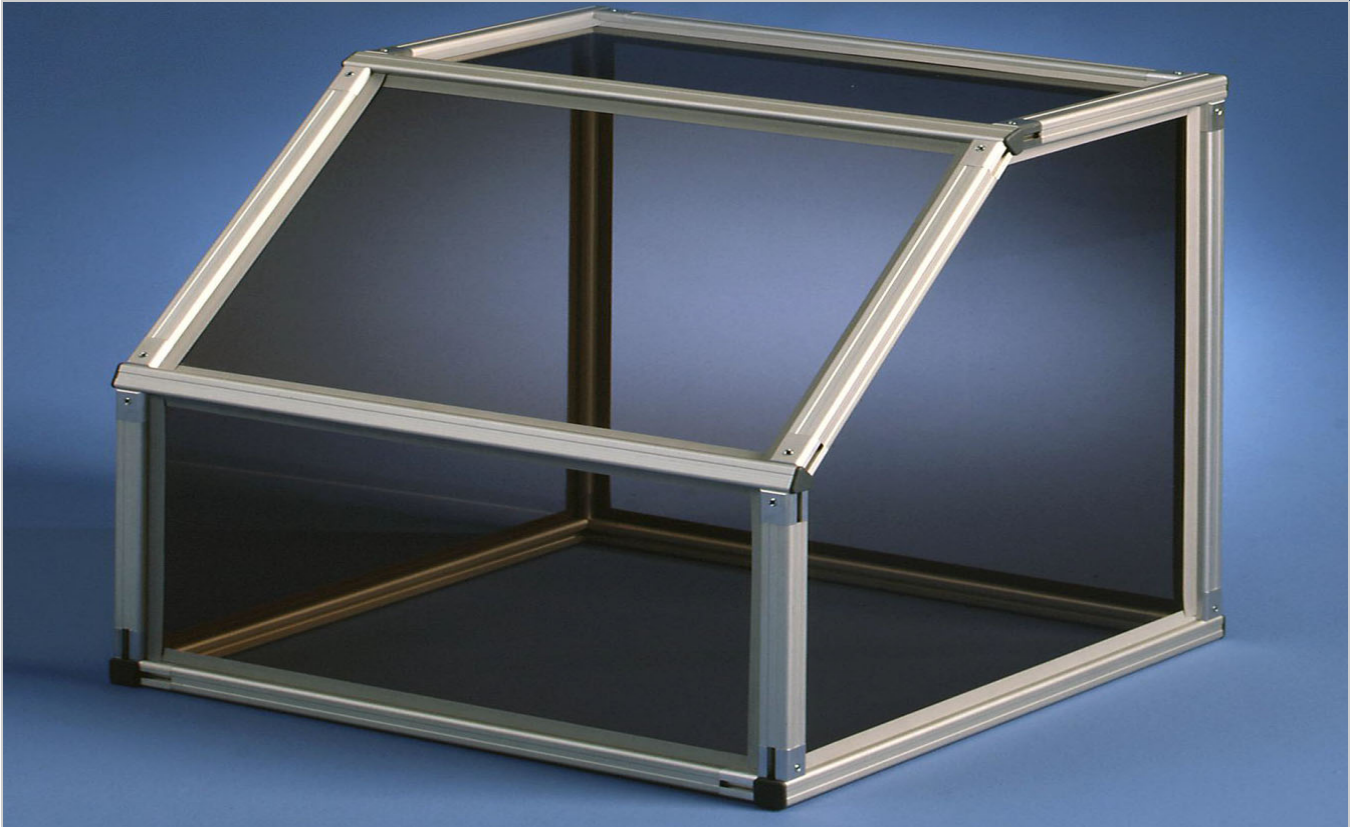

## Features

Structural system XD is based on the module 22 mm (XC: 44 mm, XF: 30 mm). Attractive styling and re-usability makes XD equally suitable for prototypes and production quantities.

Designing and building a XD structure is simple and straightforward, and the resulting design retains the flexibility typical of all products from FlexLink Systems.

- PO
- CC
- X45
- XS
- X65
- X65P
- X85
- X85P
- XH
- XK
- XKP
- X180
- X300
- GR
- CS
- XT
- HU
- WL
- WK
- XC
- XF
- XD**
- ELV
- CTL
- FST
- TR
- APX
- IDX

## Beams XD

### Lengths and tolerance aluminium beams

#### "3 m" aluminium beams

If no other tolerance is stated in the catalogue all "3 m" aluminium beams will be delivered with a length of 3030 ±5 mm

The extra length compensates for cut losses on local site.

#### "L-cut" aluminium beams

If no other range is mentioned in the catalogue L-cut aluminium beams can be ordered in the range of 30-3000 mm.

Length tolerances:

| Cut length L (mm) | Length tolerance (mm) |
|-------------------|-----------------------|
| 30-1000           | ±0,3                  |
| 1001-2000         | ±0,5                  |
| 2001-3000         | ±0,8                  |

## Support beams

### Support beam 22×22

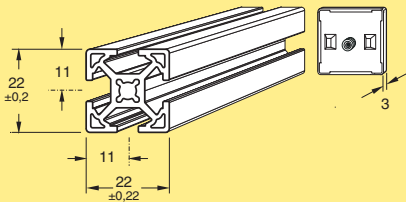

Beam 22 mm × 22 mm  
Aluminium, anodized  
Length 3 m (3030 ±5 mm) **XDBM 3x22**  
Length to order (30- 3000 mm) **XDBM Lx22**  
End cap, polyamide **XDBE 22 L**

## Cover strip

### Cover strip, PVC

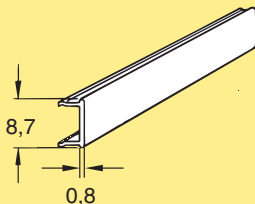

Cover strip  
Length 3 m  
Polyvinyl chloride **XDAC 3 P**

## Angle brackets

### Angle bracket, die-cast, 20×20×20



Angle bracket  
Aluminium, die-cast **XDFA 22 A**  
Mounting: MLC6S 5×8, BRB 5.3×10, XDAN 5 A

## Connecting strips

### Connecting strip

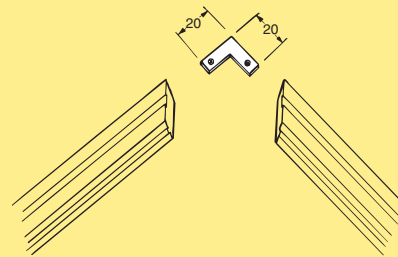

Angular connecting strip 90°  
Including set screws  
Steel, electro-zinc-plated **XDFW 9**

### Connecting strip

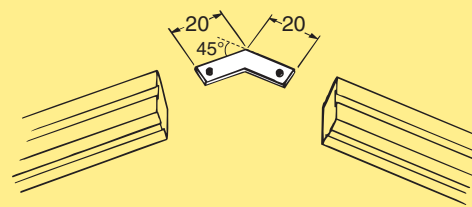

Angular connecting strip 45°  
Including set screws  
Steel, electro-zinc-plated **XDFW 9x45**

### Connecting strip

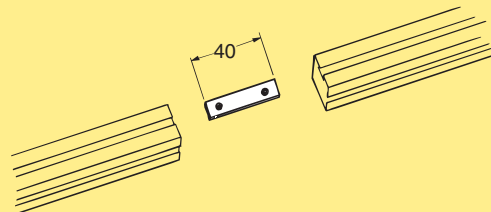

Connecting strip, straight  
Including set screws  
Steel, electro-zinc-plated **XDFC 9x40**

## T-slot nut

### T-slot nut for System XD T-slot

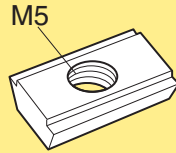
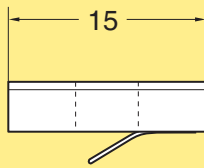

T-slot nut for XD  
Steel, zinc-chromated  
M5

**XDAN 5 A**

## Adjustable feet

### Adjustable foot

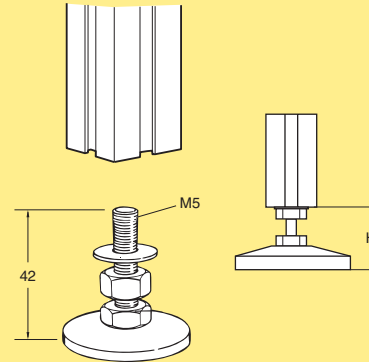

Adjustable foot (M5 screw)  
H=21-30 mm  
Steel, electro-zinc-plated  
M5 thread

**XDFS 5x30**

Including nut. Maximum vertical load 250 N

## Enclosure profiles

### Enclosure beam 22x22, four T-slots

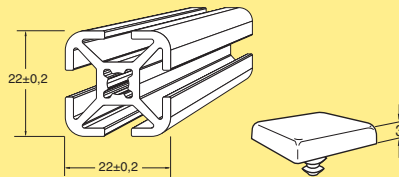

Enclosure profile, square section  
22 mm x 22 mm, four T-slots  
Aluminium, anodized  
Length 3 m (3030 ±5 mm)  
Length to order (30- 3000 mm)

**XDEB 3x22**  
**XDEB Lx22**

End cap, polyamide, grey

**XDEE 22\***

With standard XD T-slots and hole for M5  
\*Note. Contains 10 pcs.

### Enclosure beam 22x22, two T-slots

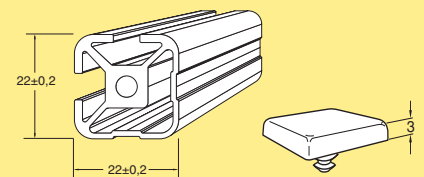

Enclosure profile, square section  
22 mm x 22 mm, two T-slots  
Aluminium, anodized  
Length 3 m (3030 ±5 mm)  
Length to order (30- 3000 mm)

**XDEB 3x22 T2**  
**XDEB Lx22 T2**

End cap, polyamide, grey

**XDEE 22\***

With standard XD T-slots and hole for M5  
\*Note. Contains 10 pcs.

### Enclosure beam 22x22, three T-slots

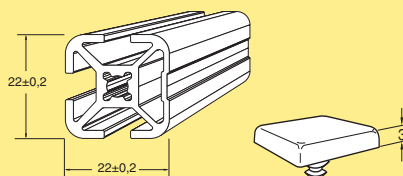

Enclosure profile, square section  
22 mm x 22 mm, three T-slots  
Aluminium, anodized  
Length 3 m (3030 ±5 mm)  
Length to order (30- 3000 mm)

**XDEB 3x22 T3**  
**XDEB Lx22 T3**

End cap, polyamide, grey

**XDEE 22\***

With standard XD T-slots and hole for M5  
\*Note. Contains 10 pcs.

### Enclosure connector kit

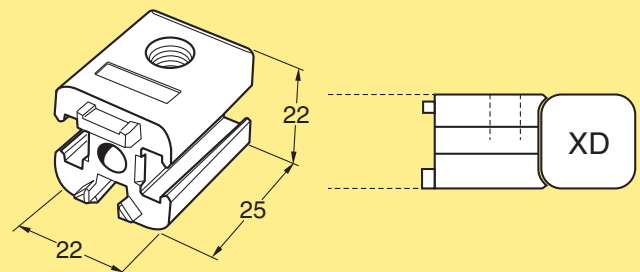

Enclosure connector kit  
Aluminium, die-cast

**XDEF 22**

Including the necessary mounting hardware

## Enclosure strips

### Rim strip

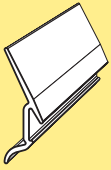

Rim strip  
Length 3 m  
Polyvinyl chloride, grey

**XDET 3 A**

### Net strip

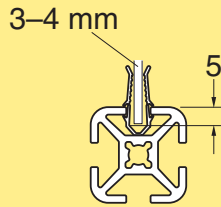
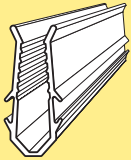

Net strip  
Length 3 m  
Polyvinyl chloride, grey

**XDET 3 C**

## Multiblock

### Multiblock

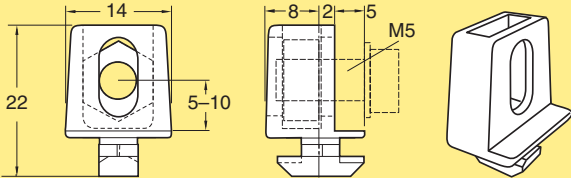

Multiblock  
Polyamide  
Including M5 square nut

**XDAM 2**

## Door accessories

### Handle assembly XC/XD/XF, polyamide

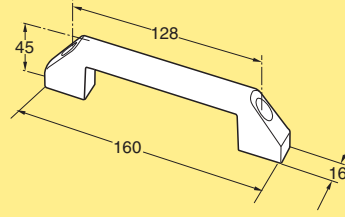

Handle assembly  
Polyamide

**XDEH 160**

Including adapter plate for XC  
Mounting XD: MC6S 5x12 (2), XDAN 5 A(2)

## Components for XD doors in XD frames

### Hinge kit XD-XD

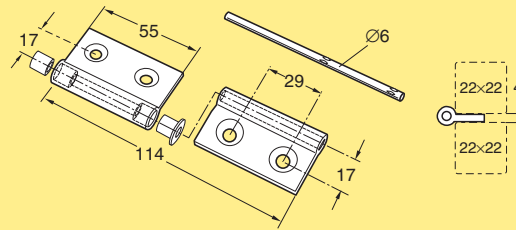

Hinge kit XD-XD  
Aluminium

**XDAH 110 B**

Including the necessary mounting hardware

## Components for XD doors in XC frames

### Ball latch lock kit XD-XC

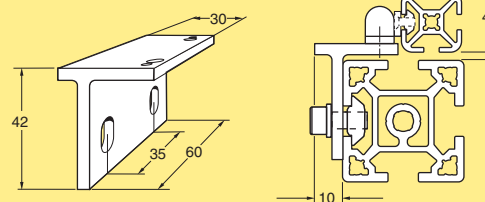

Ball latch lock kit  
Aluminium, anodized

**XDEL 60 BA**

Including ball latch and the necessary mounting hardware