

# Conveyor system XS

## Contents

System information.....	101	End drive units XS, direct drive with slip clutch .....	108
Conveyor modules .....	102	Double drive units XS.....	109
Chains XS.....	103	Bend drive unit XS.....	109
Chain accessories XS .....	104	Idler end unit XS.....	109
Beam XS .....	105	Wheel bends XS .....	110
Beam accessories XS .....	105	Plain bends XS .....	110
Slide rails XS .....	106	Vertical bends XS .....	111
Drive and idler units – introduction .....	107	Front piece XS .....	113
End drive units XS .....	108		

## System information



### Chain width 44 mm

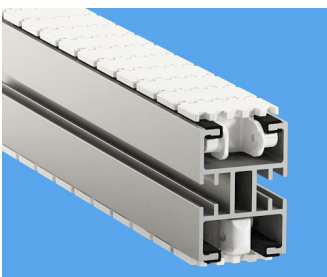

### Features

Chain permits transport of very small items which are otherwise difficult to handle. Compact and neat design.

### Examples of application areas

Small ball bearings, perfume bottles, pharmaceutical bottles, sintered metal components.

### Technical characteristics

Drive unit capacity limit.....	500 N
Chain tension limit .....	500 N
Beam width .....	45 mm
Chain width .....	44 mm
Chain pitch.....	25,4 mm
Item width .....	10–80 mm
Maximum item weight	
Horizontal transport.....	2 kg
Vertical transport.....	1 kg
Maximum weight on conveyor .....	150 kg
Maximum conveyor length.....	30 m
Maximum permitted load per link	0,5 kg

PO  
CC  
X45  
XS  
X65  
X65P  
X85  
X85P  
XH  
XK  
XKP  
X180  
X300  
GR  
CS  
XT  
HU  
WL  
WK  
XC  
XF  
XD  
ELV  
CTL  
FST  
TR  
APX  
IDX

# Conveyor modules

## Straight conveyor

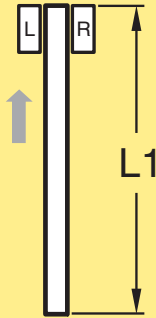

Conveyor module – straight \* **5990226**

*\*Use online configurator when ordering*

## One bend conveyor

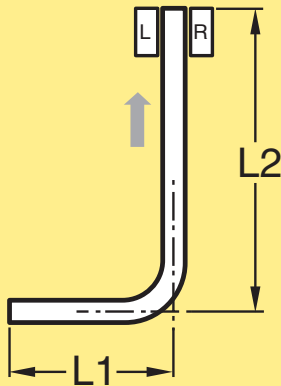

Conveyor module – one bend \* **5990230**

*\*Use online configurator when ordering*



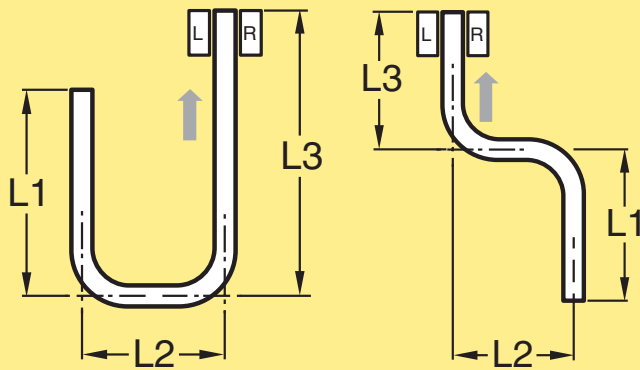







## Two bend conveyor



Conveyor module – two bends \* **5990237**

*\*Use online configurator when ordering*

## Support modules – single and multi-lane

	5995387	Single diecast
	5995388	Single end adjustable
	5995389	Single end guide roller
	5995390	Single foot plate
	5995391	Single two/three-point
	5995393	Multi single 2 lane
	5995394	Multi single 3 lane
	5995395	Multi single 4 lane
	5995396	Multi double 2 lane
	5995397	Multi double 3 lane
	5995398	Multi double 4 lane

**Plain chain**

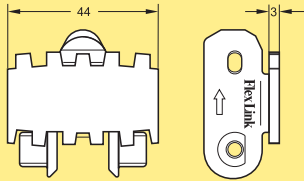

- Plain chain Length 5 m **XSTP 5**
- Plain link kit **5056061**
- Plain chain (Ultra low wear) Length 5 m **XSTP 5 C**
- Plain link kit (Ultra low wear) **n.a.**

*Note. Link kit contains 10 links, 10 pivot, 10 steel pins.*

**Cleated chain, Type D**

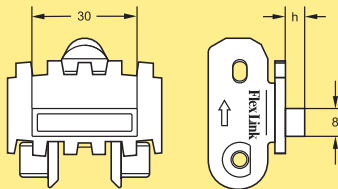

- Cleated chain Type D, Length 5 m
- h=3 **XSTF 5x3 D**
- h=5,5 **XSTF 5x5.5 D**
- h=9 **XSTF 5x9 D**
- h=27 **XSTF 5x27 D**

*Use the online configurator to specify and order.*

- Cleated link kit
- h=3 **5056052**
- h=5,5 **5056049**
- h=9 **5056045**
- h=27 **5056053**

*Note. Link kit contains 10 links, 10 pivot, 10 steel pins.*

**Cleated chain (flat top cleats)**

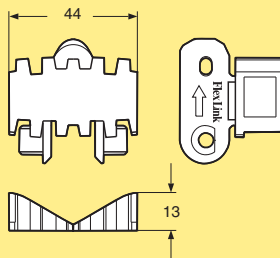

- Cleated chain Length 5 m **3903721**
- Cleated link kit **5056626**

*Note. Link kit contains 10 links, 10 pivot, 10 steel pins.*

**Other chains**

See the Chain guide for selection of other chains.

**Chain installation**

See Appendix "D. Chain installation" on page 527,

**Cleated chain, Type G**

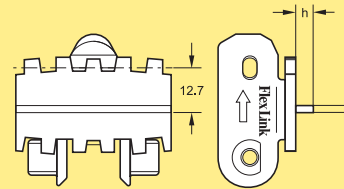

- Cleated chain Type G Length 5 m
- h=3 **XSTF 5x3 G**
- h=5 **XSTF 5x5 G**
- h=9 **XSTF 5x9 G**

*Use the online configurator to specify and order.*

- Cleated link kits
- h=3 **5056051**
- h=5 **5056050**
- h=9 **5056043**

*Note. Link kit contains 10 links, 10 pivot, 10 steel pins.*

**Steel top chain**

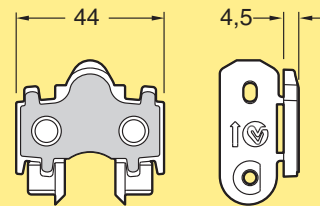

- Steel top chain Length 5 m **XSTP 5 TF**
- Steel top link kit **5056634**

*Note. Link kit contains 10 links, 10 pivot, 10 steel pins.*

## Chain accessories XS

---

### Plastic pivot for chain



Plastic pivot kit XS

**5111489**

*Plastic pivot kit, 25 pc*

### Steel pin

XLTD 4x36

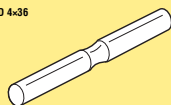

Steel pin kit XS

**5111492**

*Steel pin kit, 25 pc*

### Pin insertion tool for chain

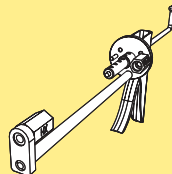
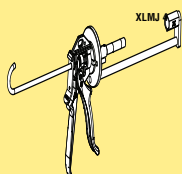

Pin insertion tool

XS-X65-XT

XS-X65-XT, PRO version\*

**XLMJ 4**

**XLMJ 4 P**

*\*This product is recommended for frequent users.*

**Conveyor beam**

Beam  
 Length 3000 +10/-0 mm  
 Length to order (30- 3000 mm)  
 Slide rail: see page 106

**XSCB 3**  
**XSCB L**

**Beam accessories XS**

**Connecting strip with set screws**

Connecting strip with set screws  
 h=20, a=30, b=50, L=130  
 Note. Contains 10 pcs.

**XSCJ 6x130**

**Cover strip for T-slot, PVC**

Cover strip for T-slot, PVC  
 Length 25 m  
 For XS-XH

**XLAB 25**

**Beam spacer**

XS	XL	XH	XK
h=16,0 mm	h=15,9 mm	h=10,5 mm	h=0,5 mm

Beam spacer  
 Aluminium, anodized  
 Length 3 m

**XLCD 3**

For connection of two conveyor beams side to side. Use M8 screw and slot nut. Two holes must be drilled, one through the spacer (9 mm) and one through the beam, to allow insertion of the screw. The diameter of the second hole depends on the size of the screw head.

# Slide rails XS

## Plastic slide rails for XS beam

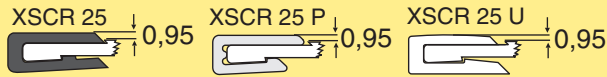

Slide rail

Length 25 m

HDPE ( $\mu=0,1-0,25$ ) (Black)

PVDF ( $\mu=0,15-0,35$ ) (Natural white)

UHMW-PE ( $\mu=0,1-0,25$ ) (White)

PA-PE ( $\mu=0,1-0,25$ ) (Grey)

**XSCR 25**

**XSCR 25 P**

**XSCR 25 U**

**XSCR 25 H**

## Rivet crimping clamp

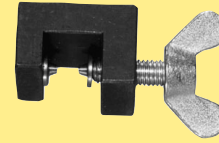

Rivet crimping clamp for XS  
For 3 mm rivets

**3924770**

## Mounting tool for slide rail



Mounting tool for slide rail XS, X65 **XLMR 140**

## Aluminium rivets

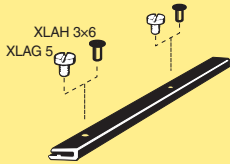

Aluminium rivets 3 mm for  
XS conveyors

**XLAH 3x6**

*Extra slide rail in plain bends must be anchored using plastic screws due to lack of space for the rivet crimping tool.*

*Note. Contains 250 pcs..*

## Cover strip

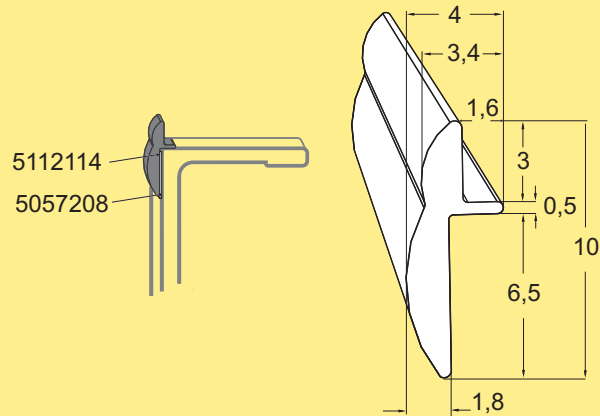

Cover strip

Length: 3 m

Material: Plastic PA 12

**5112114**

*Cover the opening on the side between the chain and beam. Primarily for straight sections and the outer curves, but can also be mounted on inner curves. Apply using a double-sided tape, see mounting instruction 5497EN in Technical library.*

## Drill fixture for slide rail

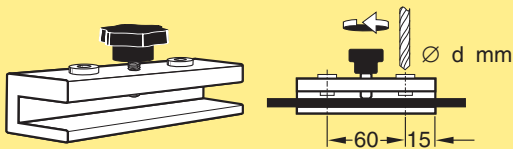

Drill fixture for XS slide rail  
d=3,2

**3924774**

## Rivet crimping pliers



Rivet crimping pliers for XS  
For 3 mm rivets

**3924776**

## Glue tape 3M



Glue tape (for XS, X65, X85, XH)  
Length 30 m

**5057208**

**Drive unit types**



The XS system includes several configurations, including direct driven units with suspended motor and transmission chain as well as drive units.

Available motors include variable speed types (V) as well as fixed speed motors (F).

**Dimension**

Note that dimensions relating to drive unit motors depend on the motor specified during the configuration.

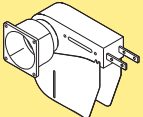
*End drive units*

Size	Direct drive, slip clutch	Suspended motor, transmission chain, slip clutch
		
Heavy	F, V	F

*Wheel bend drive units*

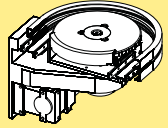
Size	Suspended motor, transmission chain, slip clutch
	
Heavy	F

*Double drive units*

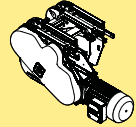
Size	Suspended motor, transmission chain, slip clutch
	
Heavy	F

**Motor specifications**

Motors are available for 230/400 V, 50 Hz and 230/460 V, 60 Hz. Variable speed motors are SEW Movimot, 380–500 V. Note that variable speed motors include a control box that adds 120 mm to the width of the motor.

IP55 available with standard oil.

IP65 available with food grade oil.

**Ordering information**

Drive units with motors must be specified using the web-based configurator. The configurator provides detailed information and step-by-step guidance in the specification process. A product code string is generated, containing the specification details. See next page for examples of code strings.

Drive units *without* motors can be ordered using the designations in the catalogue.

## End drive units XS

### End drive unit, suspended motor, slip clutch

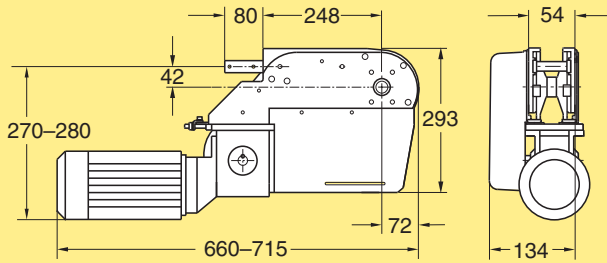

#### End drive unit

Fixed speed up to 60 m/min  
Transmission on left side  
Fixed speed  
Without motor (ISO)  
Without motor (ANSI)

**XSEB**  
**XSEB 0 HL**  
**XSEB 0 HLA**

Maximum traction force: 500 N. See page 22.  
Use online configurator when ordering.  
Effective track length: 0,80 m

### End drive unit, suspended motor, slip clutch

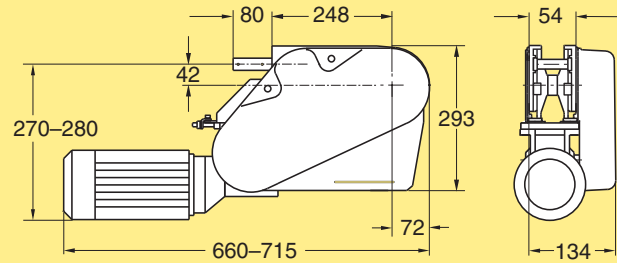

#### End drive unit

Fixed speed up to 60 m/min  
Transmission on right side  
Fixed speed  
Without motor (ISO)  
Without motor (ANSI)

**XSEB**  
**XSEB 0 HR**  
**XSEB 0 HRA**

Maximum traction force: 500 N. See page 22.  
Use online configurator when ordering.  
Effective track length: 0,80 m

## End drive units XS, direct drive with slip clutch

### End drive unit, direct drive with slip clutch

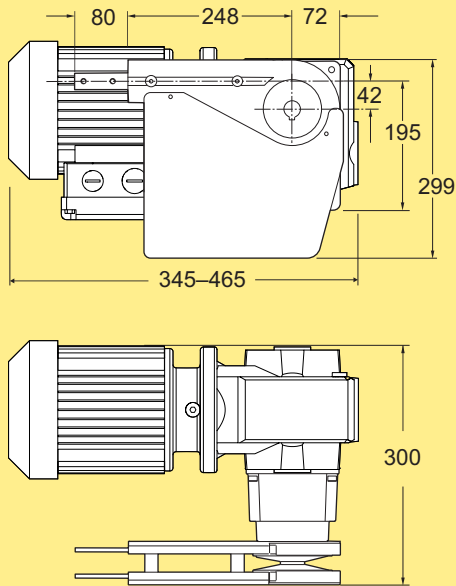

#### End drive unit, direct drive

Fixed speed up to 60 m/min  
Variable speed: see *Drive Unit Guide*

Motor on left side  
Fixed/variable speed  
Without motor  
Motor on right side  
Fixed/variable speed  
Without motor

**XSEB**  
**XSEB 0 HLP**  
**XSEB**  
**XSEB 0 HRP**

Maximum traction force: 500 N. See page 22.  
Use online configurator when ordering.  
Effective track length: 0,80 m



**Double drive unit, suspended**

Double drive unit  
 Fixed speed up to 60 m/min  
 Transmission on left side  
 A = 55 mm  
 Fixed speed  
 Without motor (ISO) **XSEB DD**  
 Without motor (ANSI) **XSEB 0 HLD55**  
**XSEB 0 HLAD55**

A = 90–350 mm  
 Without motor (ISO) **XSEB 0 HLD-**  
 Without motor (ANSI) **XSEB 0 HLAD-**

Maximum traction force: 500 N. See page 22.  
 Use online configurator when ordering.  
 Effective track length: 0,80 m

**Double drive unit, suspended**

Double drive unit  
 Fixed speed up to 60 m/min  
 Transmission on right side  
 A = 55 mm  
 Fixed speed  
 Without motor (ISO) **XSEB DD**  
 Without motor (ANSI) **XSEB 0 HRD55**  
**XSEB 0 HRAD55**

A = 90–350 mm  
 Without motor (ISO) **XSEB 0 HRD-**  
 Without motor (ANSI) **XSEB 0 HRAD-**

Maximum traction force: 500 N. See page 22.  
 Use online configurator when ordering.  
 Effective track length: 0,80 m

**Bend drive unit XS**

**Bend drive unit, suspended, 180°**

Bend drive unit, 180°  
 Fixed speed up to 30 m/min  
 Fixed speed  
 Without motor (ISO) **XSEW**  
 Without motor (ANSI) **XSEW 180/0 H**  
**XSEW 180/0 HA**

Maximum traction force: 200 N. See page 22.  
 Use online configurator when ordering.  
 Effective track length: 0,65 m

**Idler end unit XS**

**Idler end unit**

Idler end unit **XSEJ 200**

Effective track length: 0,50 m

## Wheel bends XS

### Wheel bend, 30°

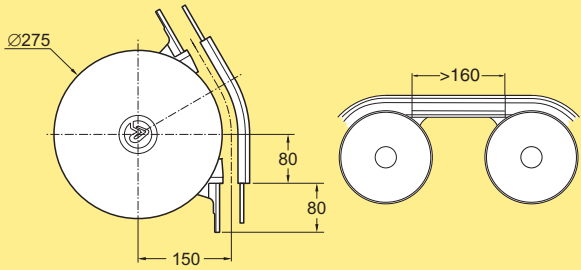

Wheel bend, 30° **XSBH 30R150**  
Effective track length: 0,25 m 1-way (0,50 m 2-way)

### Wheel bend, 90°

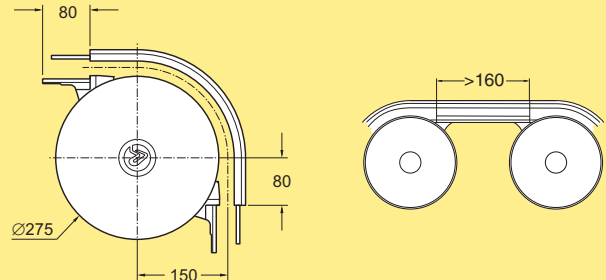

Wheel bend, 90° **XSBH 90R150**  
Effective track length: 0,40 m 1-way (0,80 m 2-way)

### Wheel bend, 45°

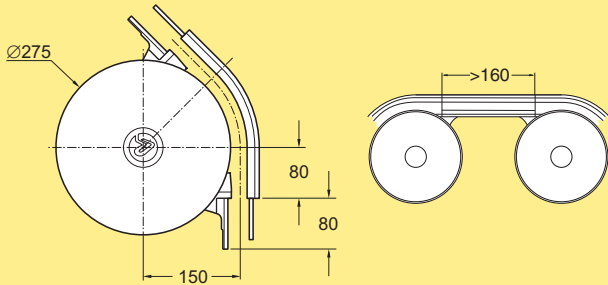

Wheel bend, 45° **XSBH 45R150**  
Effective track length: 0,30 m 1-way (0,60 m 2-way)

### Wheel bend, 180°

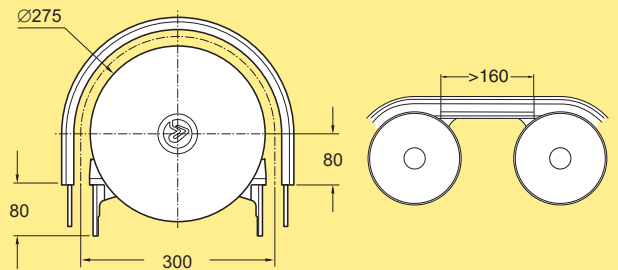

Wheel bend, 180° **XSBH 180R150**  
Effective track length: 0,65 m 1-way (1,30 m 2-way)

## Plain bends XS

### Plain bend, 30°

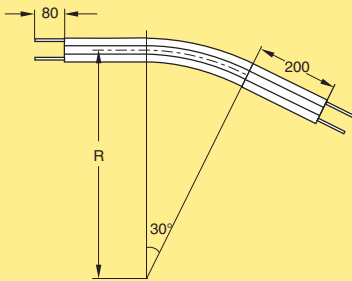

Plain bend, 30°±1°  
R=500±10 mm **XSBP 30R500**  
R=700±10 mm **XSBP 30R700**  
R=1000±10 mm **XSBP 30R1000**

Effective track lengths:  
R500: 0,70 m 1-way (1,35 m 2-way)  
R700: 0,80 m 1-way (1,55 m 2-way)  
R1000: 0,95 m 1-way (1,85 m 2-way)

### Plain bend, 45°

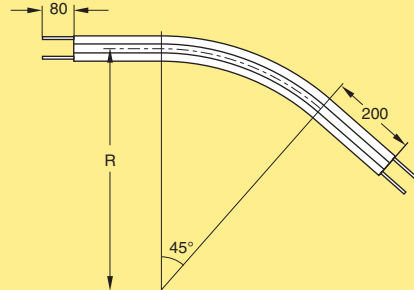

Plain bend, 45°±1°  
R=500±10 mm **XSBP 45R500**  
R=700±10 mm **XSBP 45R700**  
R=1000±10 mm **XSBP 45R1000**

Effective track lengths:  
R500: 0,80 m 1-way (1,60 m 2-way)  
R700: 0,95 m 1-way (1,90 m 2-way)  
R1000: 1,20 m 1-way (2,40 m 2-way)

**Plain bend, 60°**

Plain bend, 60°±1°  
 R=500±10 mm  
 R=700±10 mm  
 R=1000±10 mm

**XSBP 60R500**  
**XSBP 60R700**  
**XSBP 60R1000**

*Effective track lengths:*  
 R500: 0,95 m 1-way (1,85 m 2-way)  
 R700: 1,15 m 1-way (2,30 m 2-way)  
 R1000: 1,45 m 1-way (2,90 m 2-way)

**Plain bend, 90°**

Plain bend, 90°±1°  
 R=500±10 mm  
 R=700±10 mm  
 R=1000±10 mm

**XSBP 90R500**  
**XSBP 90R700**  
**XSBP 90R1000**

*Effective track lengths:*  
 R500: 1,20 m 1-way (2,40 m 2-way)  
 R700: 1,50 m 1-way (3,00 m 2-way)  
 R1000: 2,00 m 1-way (3,95 m 2-way)

**Vertical bends XS**

**Vertical bend, 5°**

Vertical bend, 5°  
**XSBV 5R300**  
*Effective track length: 0,20 m 1-way (0,40 m 2-way)*

**Vertical bend, 30°**

Vertical bend, 30°  
**XSBV 30R300**  
*Effective track length: 0,35 m 1-way (0,65 m 2-way)*

**Vertical bend, 7°**

Vertical bend, 7°  
**XSBV 7R300**  
*Effective track length: 0,22 m 1-way (0,44 m 2-way)*

**Vertical bend, 45°**

Vertical bend, 45°  
**XSBV 45R300**  
*Effective track length: 0,45 m 1-way (0,80 m 2-way)*

**Vertical bend, 60°**

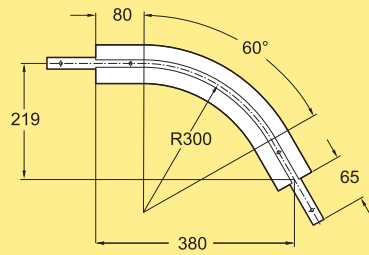

Vertical bend, 60° **XSBV 60R300**  
 Effective track length: 0,50 m 1-way (0,95 m 2-way)

**Vertical bend 90°**

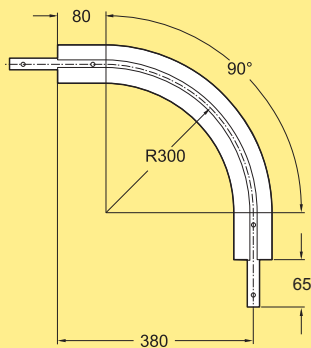

Vertical bend  
 90° ± 0,5° **XSBV 90R300**  
 R300 ± 5 mm  
 Effective track length: 0,70 m 1-way (1,30 m 2-way)

**Vertical bend, 5°–90°**

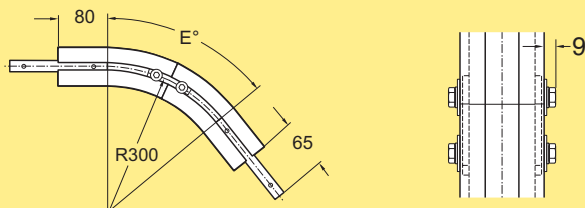

Vertical bend, 5°–90° **XSBV ER300**  
 The bend is cut in the middle to the desired angle and assembled using connecting strips. The angle "E" must be specified when ordering.

**Front piece**

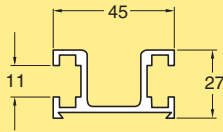

Front piece  
Length 3 m

**XSVF 3**

**Sliding strip for front piece**

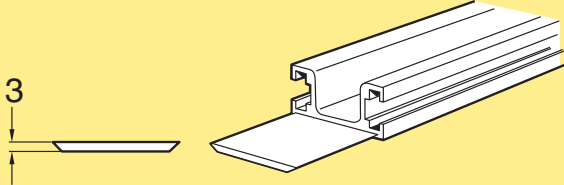

Sliding strip for front piece  
Length 2 m

**XSVG 2**

*The sliding strip must be anchored to the front piece.  
Rivets and tools for anchoring: see page 106.*

**Bend support for front piece**

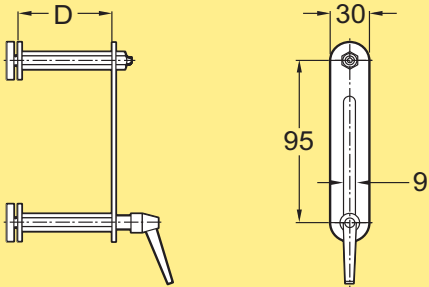

Bend support  
D=33  
D=58

**XLVS 33  
XLVS 58**

**Front piece upper bend**

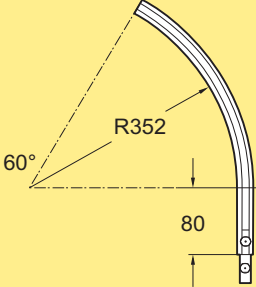

Upper bend, 60°

**XSVA 60R352**

*Includes connecting strip with screws*

**Front piece lower bend**

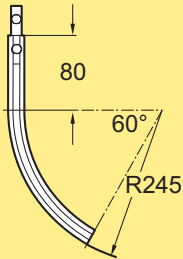

Lower bend, 60°

**XSVB 60R245**

*Includes connecting strip with screws*

**Linkage kit for front piece**

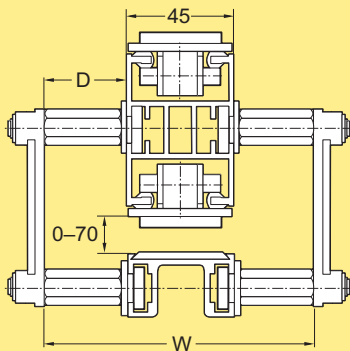

Linkage kit  
W=110, D=33  
W=160, D=58

**XLVK 33  
XLVK 58**

*Kit includes two support pairs and one locking device.*

