

Fasteners

Contents

Introduction455
 Screws, bolts, locking lever of screw type.....456

Washers457
 Nuts, locking lever of nut type.....457

Introduction

Slot nuts

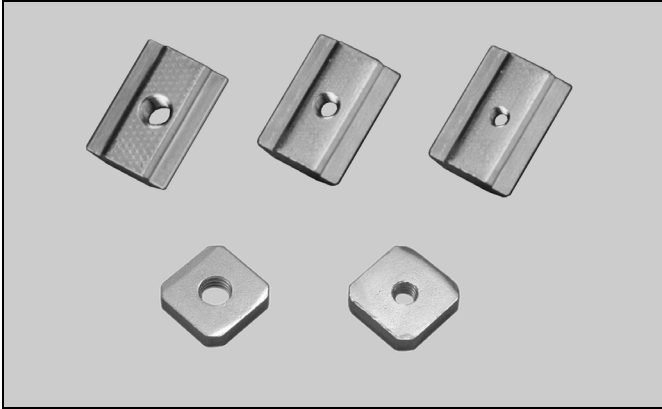

Slot nuts are used for connections to the structural system T-slots. The nuts exist in XC and XF versions.

Screws, nuts and washers



This catalogue lists a number of standard screws, nuts and washers which are needed frequently when building structural system applications.

Locking levers are recommended replacements for screws or nuts when frequent readjustment of a screw/nut connection are needed.

PO

CC

X45

XS

X65

X65P

X85

X85P

XH

XK

XKP

X180

X300

GR

CS

XT

WL

WK

XC

XF

XD

ELV

CTL

FST

TR

APX

IDX

Hex head bolt – ISO 4014/4017

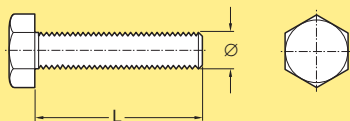

Hex head screw – ISO 4014/4017

M8, L=14 mm, Ø8 mm	M6S 8×14
M8, L=16 mm, Ø8 mm	M6S 8×16
M8, L=18 mm, Ø8 mm	M6S 8×18
M8, L=30 mm, Ø8 mm	M6S 8×30

Note. Must be ordered in multiples of 50

*Stainless steel

Hex socket head cap screw, ISO 4762

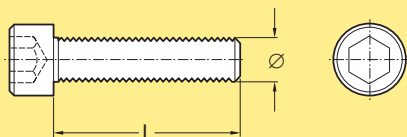

Hex socket head screws, standard
– DIN 912, ISO 4762

M5, L=12 mm, Ø5 mm	MC6S 5×12
M5, L=20 mm, Ø5 mm	MC6S 5×20
M5, L=35 mm, Ø5 mm	MC6S 5×35
M6, L=10 mm, Ø6 mm	5044478
M6, L=14 mm, Ø6 mm	MC6S 6×14
M6, L=16 mm, Ø6 mm	MC6S 6×16
M6, L=30 mm, Ø6 mm	MC6S 6×30
M6, L=50 mm, Ø6 mm	MC6S 6×50
M8, L=14 mm, Ø8 mm	MC6S 8×14
M8, L=30 mm, Ø8 mm	MC6S 8×30

Note. Must be ordered in multiples of 50

*Stainless steel

Hex head cap screw, low head DIN 7984

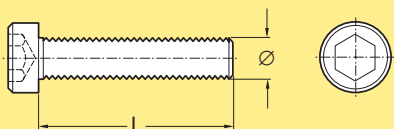

Hex socket head screw, low profile
– DIN 7984

M5, L= 8 mm, Ø5 mm	MLC6S 5×8
M5, L=10 mm, Ø 5 mm	MLC6S 5×10
M5, L=20 mm, Ø 5 mm	MLC6S 5×20
M6, L=12 mm, Ø 6 mm	MLC6S 6×12
M8, L=14 mm, Ø 8 mm	MLC6S 8×14
M8, L=30 mm, Ø 8 mm	MLC6S 8×30
M8, L=35 mm, Ø 8 mm	MLC6S 8×35

Note. Must be ordered in multiples of 50

Hexagon socket countersunk head screw ISO 10642

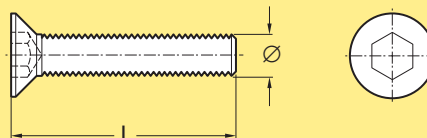

Hex socket head screw, countersunk
– DIN EN ISO 10642

M6, L=12 mm, Ø6 mm	MF6S 6×12
M6, L=14 mm, Ø6 mm	MF6S 6×14
M6, L=16 mm, Ø6 mm	MF6S 6×16
M6, L=30 mm, Ø6 mm	MF6S 6×30
M8, L=18 mm, Ø8 mm	MF6S 8×18
M8, L=30 mm, Ø8 mm	MF6S 8×30
M8, L=40 mm, Ø8 mm	MF6S 8×40

Note. Must be ordered in multiples of 50

Selftapping screw, countersunk DIN 7500- ME

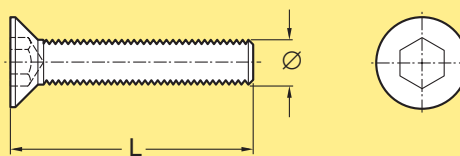

Selftapping screw
M8, L=30 mm, Ø8 mm
Countersunk

MF6S-TT 8×30

Note. Must be ordered in multiples of 50

Selftapping screw, hex socket head DIN 7500- EE

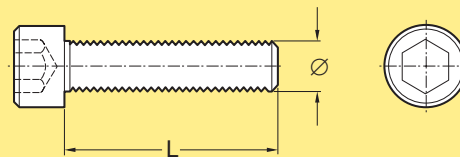

Selftapping screw
M6, L=30 mm, Ø6 mm
Hex socket head

MC6S-TT 6×30

Note. Must be ordered in multiples of 50

T-bolt for conveyor beam

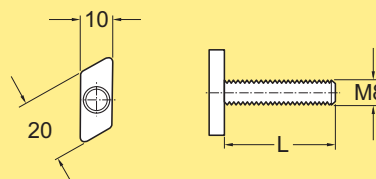

T-bolt M8

L= 17,8 mm	XLAT 17
L= 24 mm	XLAT 24
L= 35 mm	XLAT 35
L= 53 mm	XLAT 53
L= 71 mm	XLAT 71

Note. Must be ordered in multiples of 50

Locking lever, screw type

Locking lever with M8 screw
Thread length 10 mm **XLAL 8x10**

Washers

Washers

Flat washer
For M5, d=5,3 mm, D=10 mm **BRB 5.3x10**
For M6, d=6,4 mm, D=12 mm **BRB 6.4x12**
For M8, d=8,4 mm, D=16 mm **BRB 8.4x16**

Note. Must be ordered in multiples of 50

Nuts, locking lever of nut type

Nut for T-bolt DIN 985:1987 Class 8

Locking nut M8 for T-bolt **XLAN 8**

Note. Must be ordered in multiples of 50

Square nut for System XC T-slot

Square nut for XC
M8 thread **XLAQ 8**
M6 thread **XLAQ 6**

Note. Must be ordered in multiples of 50

Nut – ISO 4032

M6 nut **M6M M6**

Note. Must be ordered in multiples of 50

T-slot nut for System XF T-slot

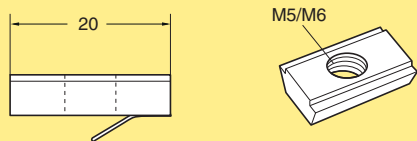

T-slot nut for XF

Steel, zinc-chromated

M5 **XFAN 5***

M5, multipack (500 pcs) **5056131**

M6 **XFAN 6***

M6, multipack (500 pcs) **5056130**

**Note. Must be ordered in multiples of 10*

T-slot nut for System XC T-slot

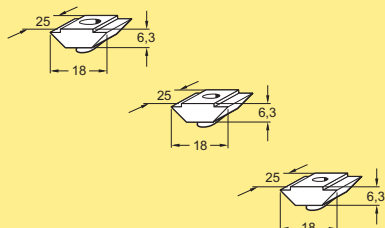

T-slot nut for XC

Steel, zinc-chromated

M5 **XCAN 5***

M5, multipack (250 pcs) **5056129**

M6 **XCAN 6***

M6, multipack (250 pcs) **5056128**

M8 **XCAN 8***

M8, multipack (250 pcs) **5056127**

**Note. Must be ordered in multiples of 10*

Locking lever, nut type

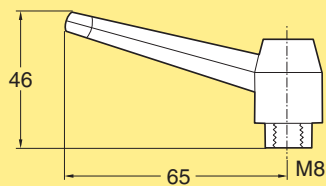

Locking lever with M8 thread

XLAL 8