

Stainless steel conveyor system XLX

Contents

System information.....	21	Idler end unit XLX.....	25
Chains XLX.....	22	Wheel bends XLX.....	26
Chain accessories XLX.....	23	Plain bends XLX.....	27
Beams XLX.....	23	Vertical bends XLX.....	27
Beam accessories XLX.....	23		
Slide rails XLX.....	24		
End drive units XLX.....	25		

System information



Chain width 63 mm



Features

- Wide range of wet applications
- Wedge conveyors
- High speed solutions
- Many chain types available from the standard XL range

Examples of application areas

Filling lines within the food, personal products and liquid pharmaceuticals segments.

Technical characteristics

Drive unit capacity	500 N
Chain tension limit	500 N
Beam width	65 mm
Chain width	63 mm
Item width	15–140 mm
Maximum item weight	
Horizontal transport	10 kg
Vertical transport.....	2 kg
Maximum weight on conveyor.....	150 kg
Maximum conveyor length	40 m

PO

XLX

X85X

X180X

X300X

WL
222X

WL
273X

WL
374X

WL
526X

WL
678X

CSX

GRX

FSTX

TR

APX

IDX

Chains XLX

Plain chain

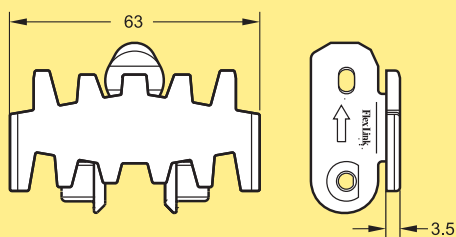

Plain chain
Length 5 m

XLTP 5

Plain link kit *

5056085

Plain chain (Ultra low wear)
Length 5 m

XLTP 5 C

Plain link kit (Ultra low wear)

n.a.

* Link kit contains 10 links, 10 pivots, 10 steel pins

Friction top chain

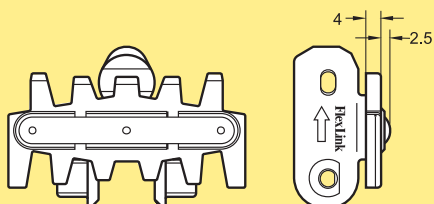

Friction top chain
Length 5 m

XLTP 5 FP

Use the online configurator to specify and order.

Friction top chain, Length 5 m

XLTP 5 F

Friction top link kit *

5056081

* Link kit contains 10 links, 10 pivots, 10 steel pins

Flat top friction chain

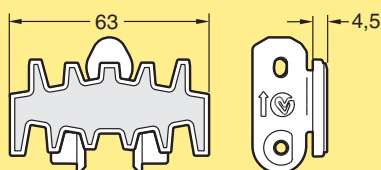

Flat top friction chain
Length 5 m

XLTP 5 FA

Flat top friction kit *

5057606

* Link kit contains 10 links, 10 pivots, 10 steel pins

Flexible cleat chain, Type C

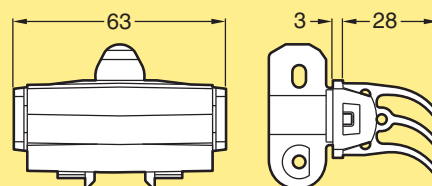

Flexible cleat chain Type C
Length 5 m

XLTE 5 C

Flexible cleat link kit *

5055601

Flexible cleat top kit **

5056589

Flexible cleat top kit ***

5056558

* 10 complete links+pivots+pins

** 10 base links XLTE 63 D+pivots+pins

*** 10 cleat tops XLTX 55 C

Flexible cleat chain, Type D

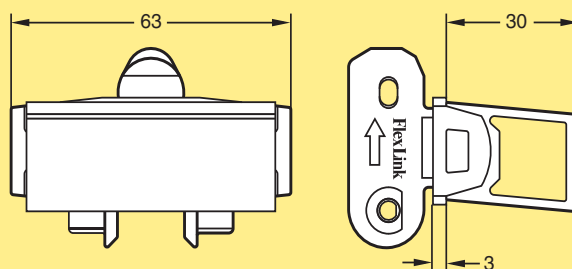

Flexible cleat chain Type D
Length 5 m

XLTE 5 D

Flexible cleat link kit *

5056589

Flexible cleat top kit **

5058089

* 10 base links XLTE 63 D+pivots+pins.

** 10 cleat tops XLTX 55 D

Chain accessories XLX

Plastic pivot



Plastic pivot XS, XL

5111489

Plastic pivot kit contains 25 items

Steel pin

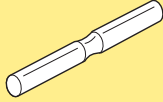

Steel pin XS, XL

5111492

Steel pin kit contains 25 items

Pin insertion tool for chain

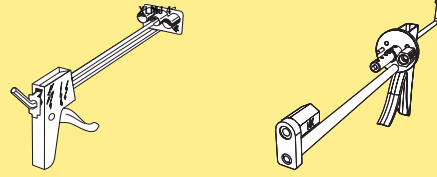

Pin insertion tool

XS-XL-XT

XS-XL-XT, PRO version*

XLMJ 4

XLMJ 4 P

**This product is recommended for frequent users.*

Beams XLX

Conveyor beam

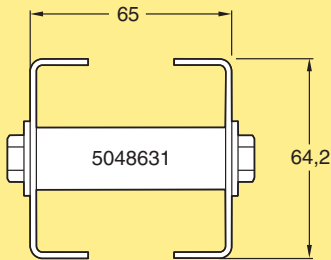

Beam

Length 3 m

Length to order (0,2–3,0 m)

XLCBX 3

XLCBX L

Beam section for chain installation

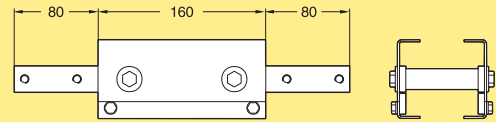

Beam section for chain installation

XLCCX 160

Including connecting strips

Screws and nuts for the connecting strips are not included

Beam accessories XLX

Connecting strip

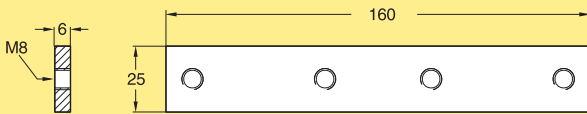

Connecting strip

XLCJX 6×160

Mounting: M6S 8×12 A4 (4), BRB 8,4×24 A4 (4)

Screws and nuts are not included

PO

XLX

X85X

X180X

X300X

WL
222X

WL
273X

WL
374X

WL
526X

WL
678X

CSX

GRX

FSTX

TR

APX

IDX

Slide rails XLX

Plastic slide rail for XL, X85, XH beam

XLCR 25 P/H



XLCR 25 U



Slide rail

Length 25 m

Polyethylene (PE) (Black)

PVDF (Natural white)

UHMW-PE (White)

PA-PE (Grey)

XLCR 25
XLCR 25 P
XLCR 25 U
XLCR 25 H

Installation of slide rails

Drill fixture for slide rail

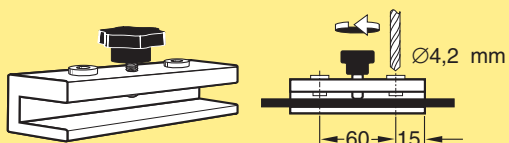

Drill fixture for slide rail

3920500

Plastic screw for slide rail

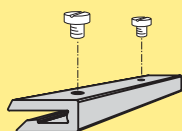

Plastic screw 5 mm for XL-X85-XH

XLAG 5

Note. Must be ordered in multiples of 50

Stainless steel rivet

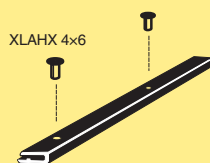

Stainless steel rivet, 4 mm

XLAHX 4x6

Note. Must be ordered in multiples of 100

Rivet crimping pliers for XL-X85-XH



Rivet crimping pliers

For 4 mm rivets

5051395

Rivet crimping clamp for XL-X85-XH

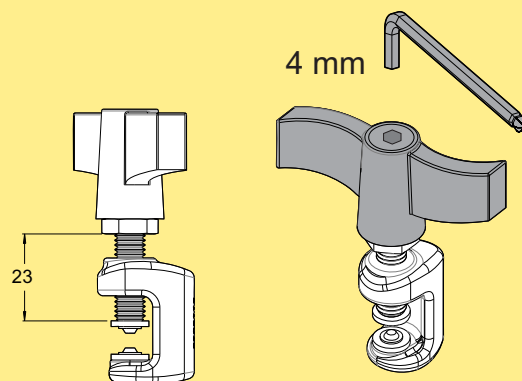

Rivet crimping clamp

For 4 mm rivets

(note: Allen key not included)

3923005

Mounting tool for slide rail

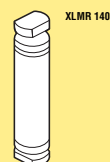

Mounting tool XL

XLMR 140

End drive units XLX

End drive unit

End drive unit
Transmission on left side
Fixed/variable speed *
Without motor

**XLEBX
XLEBX 0 HLP**

Effective track length: 0,80 m
* Use online configurator when ordering.

End drive unit

End drive unit
Transmission on right side
Fixed/variable speed *
Without motor

**XLEBX
XLEBX 0 HRP**

Effective track length: 0,80 m
* Use online configurator when ordering.

Drive unit shaft kit

Drive unit shaft kit for stainless steel drive units Series X

5051185

For SEW SA37 gearbox. Including the necessary mounting hardware

Idler end unit XLX

Idler end unit

Idler end unit

XLEJX 320

Effective track length: 0,80 m

PO

XLX

X85X

X180X

X300X

WL
222X

WL
273X

WL
374X

WL
526X

WL
678X

CSX

GRX

FSTX

TR

APX

IDX

Wheel bends XLX

Wheel bend, 30°

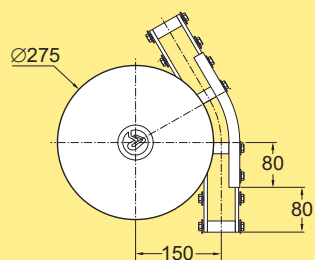

Wheel bend, 30° **XLBHX 30R150**
Effective track length: 0,25 m (2-way 0,50 m)

Wheel bend, 90°

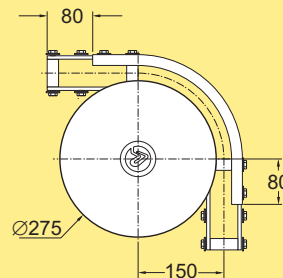

Wheel bend, 90° **XLBHX 90R150**
Effective track length: 0,40 m (2-way 0,80 m)

Wheel bend, 45°

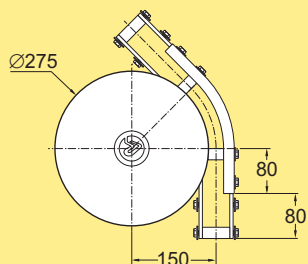

Wheel bend, 45° **XLBHX 45R150**
Effective track length: 0,30 m (2-way 0,60 m)

Wheel bend, 180°

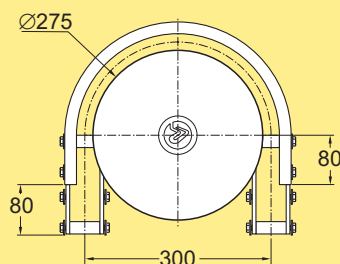

Wheel bend, 180° **XLBHX 180R150**
Effective track length: 0,65 m (2-way 1,30 m)

Safety cover for wheel bend XLBHX

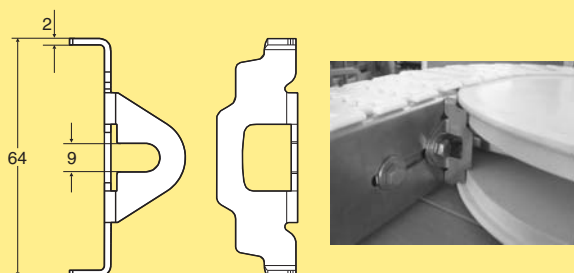

Safety cover for wheel bend XLBHX **5056997**
Each item consists of two (2) covers 5056925.
Use the existing screw and washer for assembly.

Plain bends XLX

Plain bend, 90°

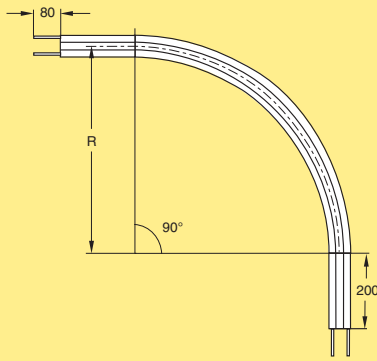

Plain bend, 90°

R=500
R=1000

XLBPX 90R500
XLBPX 90R1000

Effective track lengths:

R500: 1,20 m (2-way: 2,40 m)

R1000: 2,00 m (2-way: 3,95 m)

Note

Other angles and radii are available on request.

Vertical bends XLX

Vertical bend 5°

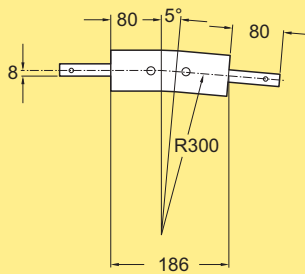

Vertical bend, 5°

XLBVX 5R300

Effective track length: 0,20 m 1-way (0,40 m 2-way)

Vertical bend 15°

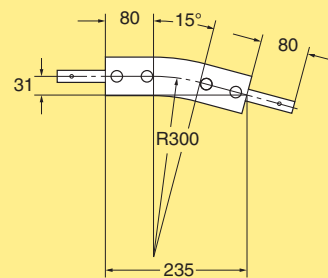

Vertical bend, 15°

XLBVX 15R300

Effective track length: 0,25 m 1-way (0,50 m 2-way)

Note

Other angles and radii are available on request.

PO

XLX

X85X

X180X

X300X

WL
222X

WL
273X

WL
374X

WL
526X

WL
678X

CSX

GRX

FSTX

TR

APX

IDX

