

Structural system XF

Contents

System information.....	439	Feet XF.....	441
Beams XF.....	440	Enclosure components XF.....	442
Connectors XF.....	440		

System information

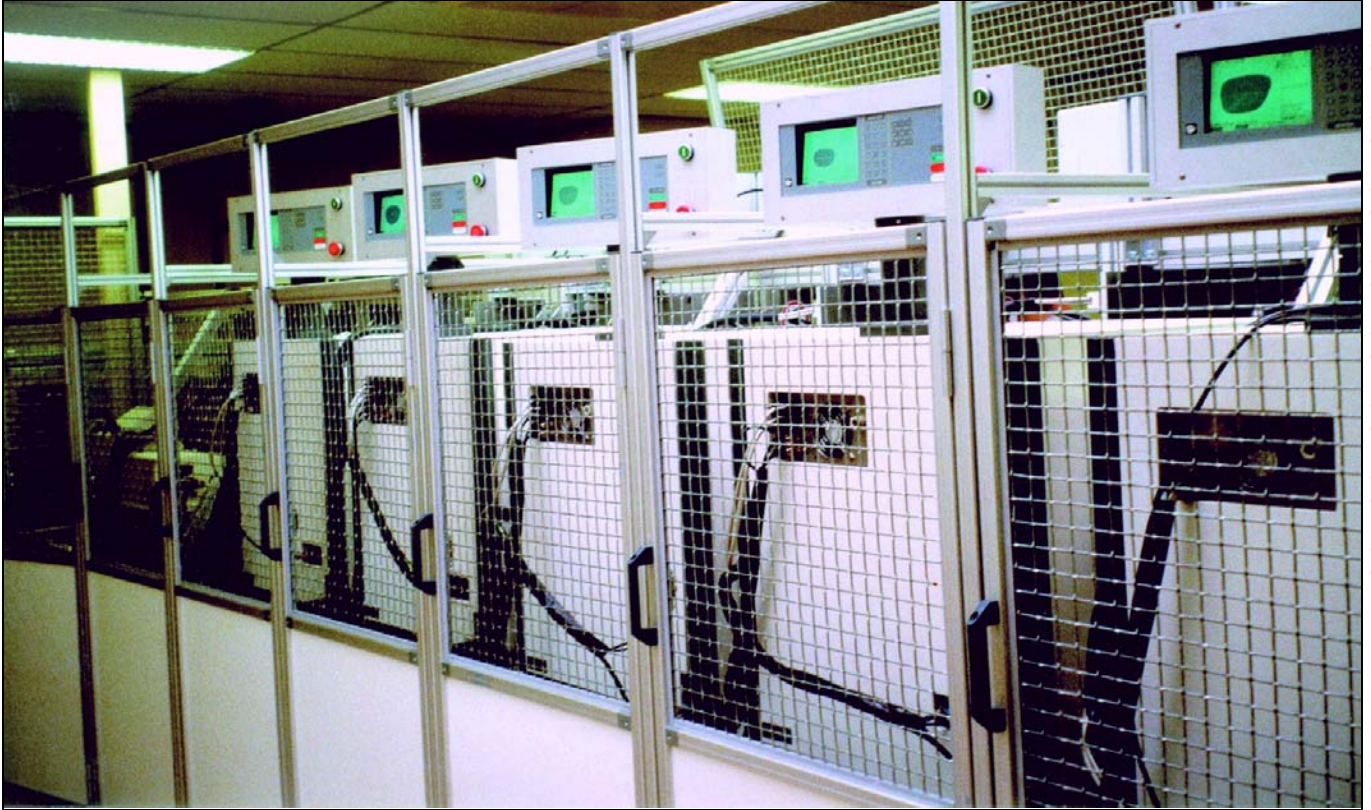

Features

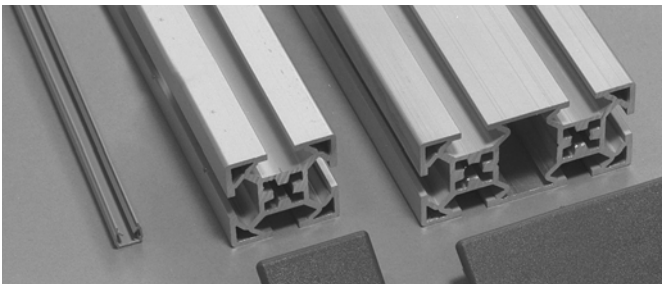

The XF system includes two basic beam types:

- support beams (XFBM) in cross-sectional dimensions 30 mm x 30 mm and 30 mm x 60 mm
- several enclosure beams (XFEB) intended for enclosure frameworks.

T-slot dimensions

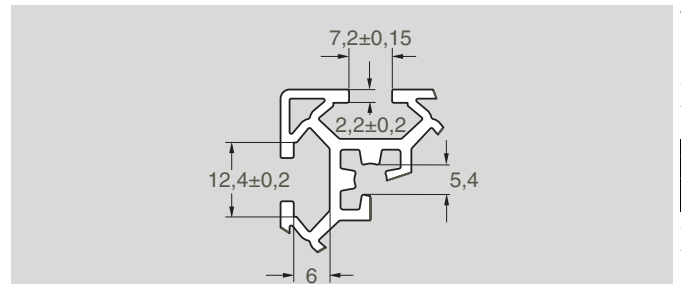

All support beams have holes for M6 screws in the corners for connecting mounting plates, end plates etc. Always use roller threading to ensure a reliable screw connection.

P0
CC
X45
XS
X65
X65P
X85
X85P
XH
XK
XKP
X180
X300
GR
CS
XT
WL
WK
XC
XF
XD
ELV
CTL
FST
TR
APX
IDX

Beams XF

Beam specifications

Beam type	Cross-section mm ²	Weight kg/m	I _x mm ⁴ ×10 ⁴	I _y mm ⁴ ×10 ⁴	W _x mm ³ ×10 ³	W _y mm ³ ×10 ³
XFBM ..x30	345	0,93	3,00	3,00	2,00	2,00
XFBM ..x30x60	582	1,57	21,3	5,29	7,11	3,53
XFEB ..x30	342	0,92	2,99	2,99	1,99	1,99
XFEB ..x30 T3	340	0,91	2,92	3,01	1,95	2,00
XFEB ..x30 T2	340	0,91	2,94	2,94	1,96	1,96

Support beams

Support beam 30x60

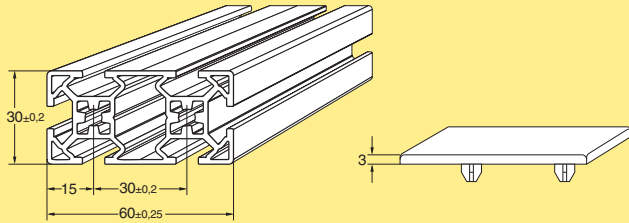

Beam 30 mm × 60 mm
Aluminium, anodized
Length 3 m (3030 ±5 mm)
Length to order (30- 3000 mm) **XFBM 3x30x60**
End cap, polyamide, grey **XFBE 30x60***

T-slot dimensions: See page 439.
Beam weight: 1,57 kg/m
**Note. Must be ordered in multiples of 10*

Support beam 30x30

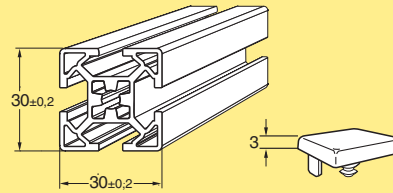

Beam 30 mm × 30 mm
Aluminium, anodized
Length 3 m (3030 ±5 mm) **XFBM 3x30**
Length to order (30- 3000 mm) **XFBM Lx30**

End cap, polyamide, grey **XFBE 30***

T-slot dimensions: See page 439.
Beam weight: 0,93 kg/m
**Note. Must be ordered in multiples of 10*

Cover strip

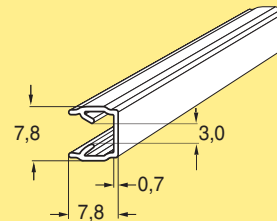

Cover strip for T-slot
Length 3 m
Polyvinyl chloride, grey **XFAC 3 T**

Beams for enclosures

FLexLink beams for enclosures: see page 442.

Connectors XF

Angle bracket, die-cast, 28x28x26

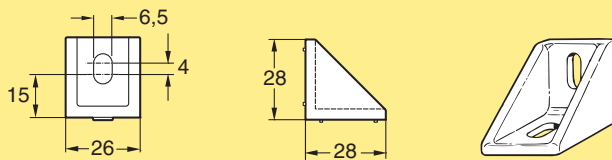

Angle bracket
Aluminium, die-cast **XFFA 30 A**
Mounting: MLC6S 6x12 (2), BRB 6,4x12 (2), XFAN 6 (2)

Angle bracket for corners, die-cast

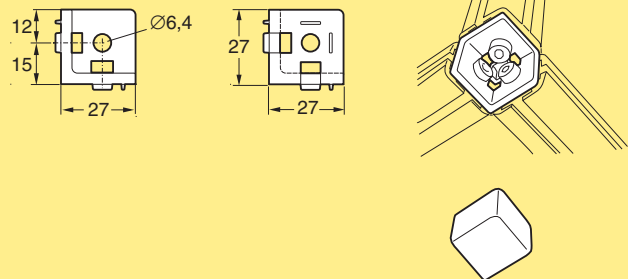

Angle bracket for corners
Zinc, die-cast **XFFA 30 C**
Mounting: MC6S-TT 6x30 (3)

End cap for corner bracket

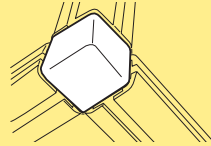

End cap for corner bracket
Polyamide

XFBE 30 C*

Note. Use XFEE 30 C when XFFA 30 C is used with enclosure beams. See page 442.
*Note. Must be ordered in multiples of 10

Mounting plate 30x70

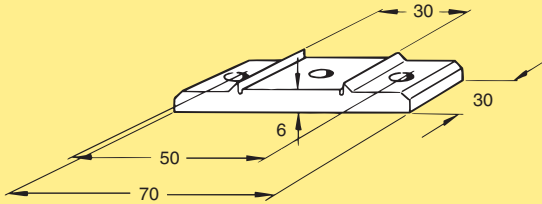

Mounting plate for beam XFBM ...x30
Aluminium, anodized

XFFB 30

Mounting: MC6S 6x14 (2), BRB 6,4x12 (2), XFAN 6 (2) and MF6S 6x30

Fastener yoke 30 mm

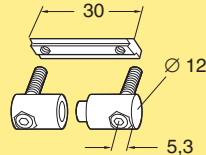

Fastener yoke assembly
Length 30 mm

XFAF 30

Fastener yoke 60 mm

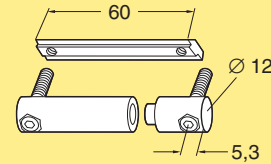

Fastener yoke assembly
Length 60 mm

XFAF 60

Drill fixture

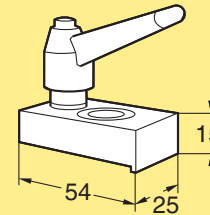

Drill fixture for fastener yokes
(Ø12,2 mm)

XFAD 12

T-slot nut for System XF T-slot

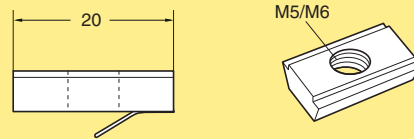

T-slot nut for XF
Steel, zinc-chromated

- M5
- M5, multipack (500 pcs)
- M6
- M6, multipack (500 pcs)

XFAN 5*
5056131
XFAN 6*
5056130

*Note. Must be ordered in multiples of 10

CC
X45
XS
X65
X65P
X85
X85P
XH
XK
XKP

X180
X300
GR
CS
XT
WL

WK

XC

XF

XD

ELV

CTL

FST

TR

APX

IDX

Feet XF

Adjustable foot M6

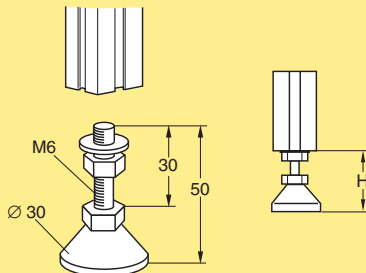

Adjustable foot
H=28–36 mm
Steel, electro-zinc-plated
M6 thread

XFFS 6x30

Maximum vertical load 400 N

Floor attachment bracket

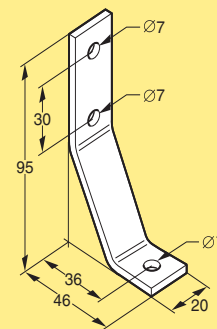

Floor attachment bracket
Stainless steel

XFFA 100 S

Including the necessary mounting hardware

Enclosure beam 30×30, four T-slots

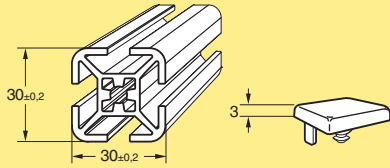

Enclosure profile, square section
 30 mm × 30 mm, four T-slots
 Aluminium, anodized
 Length 3 m (3030 ±5 mm) **XFEB 3×30**
 Length to order (30- 3000 mm) **XFEB L×30**

End cap, polyamide, grey **XFEE 30***

With standard XF T-slots and hole for M6
 Beam weight: 0,92 kg/m
 *Note. Must be ordered in multiples of 10

Enclosure connector kit

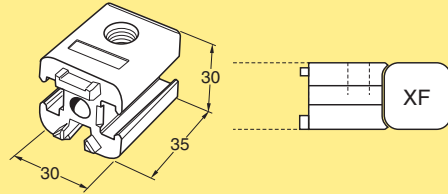

Enclosure connector kit
 Zinc, die-cast **XFEE 30**
 Including the necessary mounting hardware

Enclosure beam 30×30, three T-slots

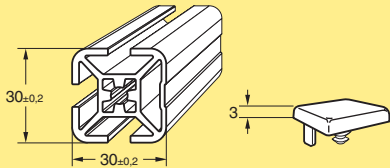

Enclosure profile, square section
 30 mm × 30 mm, three T-slots
 Aluminium, anodized
 Length 3 m (3030 ±5 mm) **XFEB 3×30 T3**
 Length to order (30- 3000 mm) **XFEB L×30 T3**

End cap, polyamide, grey **XFEE 30***

With standard XF T-slots and hole for M6
 Beam weight: 0,91 kg/m
 *Note. Must be ordered in multiples of 10

Angle bracket for corners

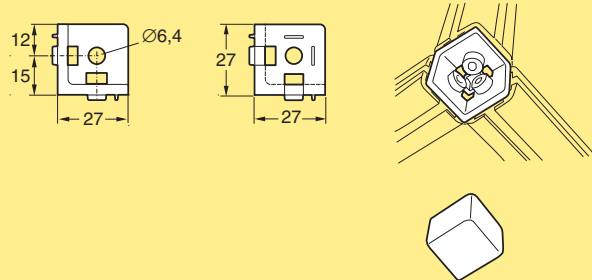

Angle bracket for corners
 Zinc, die-cast **XFFA 30 C**

Mounting: MC6S-TT 6×30 (3)

End cap

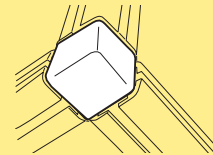

End cap for corner bracket when
 used with enclosure beams
 Polyamide **XFEE 30 C**

Note. Must be ordered in multiples of 10

Enclosure beam 30×30, two T-slots

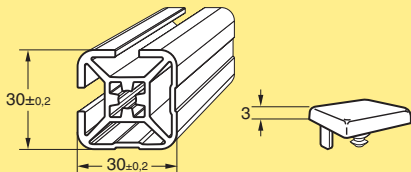

Enclosure profile, square section
 30 mm × 30 mm, two T-slots
 Aluminium, anodized
 Length 3 m (3030 ±5 mm) **XFEB 3×30 T2**
 Length to order (30- 3000 mm) **XFEB L×30 T2**

End cap, polyamide, grey **XFEE 30***

With standard XF T-slots and hole for M6
 Beam weight: 0,91 kg/m
 *Note. Must be ordered in multiples of 10

Corner bracket

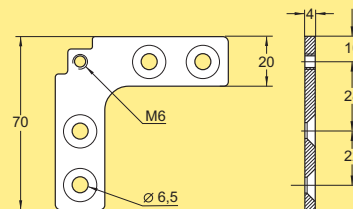

Corner bracket, four-pack kit
 Aluminium **5053010**

Including the necessary mounting hardware

Multiblock

Multiblock
Polyamide
Including M6 square nut

XFAM 6

Hinge kit XF-XF

Hinge kit XF-XF
Aluminium
Including the necessary mounting hardware

XFAH 110 B

Rim strip

Rim strip
Length 3 m
Polyvinyl chloride, grey

XFET 3 A

Handle assembly XC/XF, polyamide

Handle assembly
Polyamide
Including adapter plate for XC
Mounting XF: MC6S 5x12 (2), XFAN 5 (2)

XDEH 160

Net strip

Net strip
Length 3 m
Polyvinyl chloride, grey

XFET 3 C

Ball latch lock kit XF-XF

Ball latch lock kit
Aluminium, anodized
Including ball latch and the necessary mounting hardware

XFEL 60 B

Sliding door profile

Sliding door profile
Length 3 m
Polyvinyl chloride, grey

XFET 3 D

Safety switch bracket kit XF-XF

Safety switch bracket kit
Aluminium, anodized
Including the necessary mounting hardware. For safety switches Schmersal AZ 15/16-B1 and Guardmaster Trojan 5 (not included).

XFEL 60 W

Hinge kit XF-XC

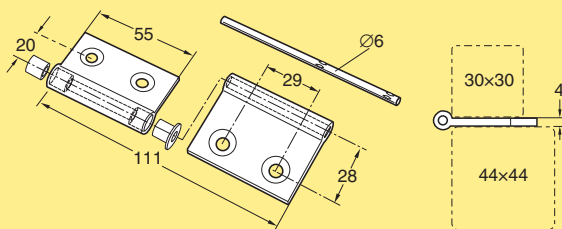

Hinge kit XF-XC

Aluminium, anodized

XFAH 110 A

Including the necessary mounting hardware

Ball latch lock kit XF-XC

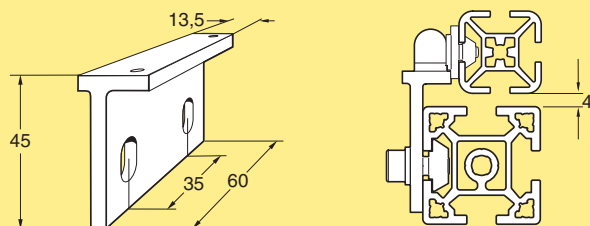

Ball latch lock kit

Aluminium, anodized

XFEL 60 BA

Including ball latch and the necessary mounting hardware

Safety switch bracket kit XF-XC

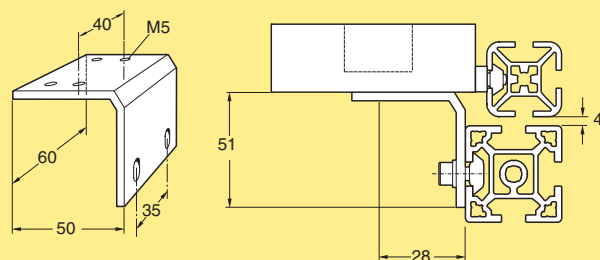

Safety switch bracket kit

Aluminium, anodized

XFEL 60 WA

Including the necessary mounting hardware. For safety switches Schmersal AZ 15/16-B1 and Guardmaster Trojan 5 (not included).

Sliding element for T-slot

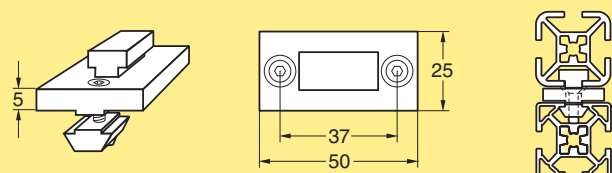

Sliding element for T-slot
UHMW-PE

XFLB 25x50

Including screws and nut